

# The MIT EPPA6 Model: Economic Growth, Energy Use, and Food Consumption

Y.-H. Henry Chen, Sergey Paltsev, John M. Reilly, Jennifer F. Morris  
and Mustafa H. Babiker



Report No. 278  
March 2015

The MIT Joint Program on the Science and Policy of Global Change combines cutting-edge scientific research with independent policy analysis to provide a solid foundation for the public and private decisions needed to mitigate and adapt to unavoidable global environmental changes. Being data-driven, the Program uses extensive Earth system and economic data and models to produce quantitative analysis and predictions of the risks of climate change and the challenges of limiting human influence on the environment—essential knowledge for the international dialogue toward a global response to climate change.

To this end, the Program brings together an interdisciplinary group from two established MIT research centers: the Center for Global Change Science (CGCS) and the Center for Energy and Environmental Policy Research (CEEPR). These two centers—along with collaborators from the Marine Biology Laboratory (MBL) at Woods Hole and short- and long-term visitors—provide the united vision needed to solve global challenges.

At the heart of much of the Program's work lies MIT's Integrated Global System Model. Through this integrated model, the Program seeks to: discover new interactions among natural and human climate system components; objectively assess uncertainty in economic and climate projections; critically and quantitatively analyze environmental management and policy proposals; understand complex connections among the many forces that will shape our future; and improve methods to model, monitor and verify greenhouse gas emissions and climatic impacts.

This reprint is one of a series intended to communicate research results and improve public understanding of global environment and energy challenges, thereby contributing to informed debate about climate change and the economic and social implications of policy alternatives.

Ronald G. Prinn and John M. Reilly,  
*Program Co-Directors*

**For more information, contact the Program office:**

MIT Joint Program on the Science and Policy of Global Change

**Postal Address:**

Massachusetts Institute of Technology  
77 Massachusetts Avenue, E19-411  
Cambridge, MA 02139 (USA)

**Location:**

Building E19, Room 411  
400 Main Street, Cambridge

**Access:**

Tel: (617) 253-7492

Fax: (617) 253-9845

Email: [globalchange@mit.edu](mailto:globalchange@mit.edu)

Website: <http://globalchange.mit.edu/>

# The MIT EPPA6 Model: Economic Growth, Energy Use, and Food Consumption

Y.-H. Henry Chen<sup>\*†</sup>, Sergey Paltsev<sup>\*</sup>, John M. Reilly<sup>\*</sup>, Jennifer F. Morris<sup>\*</sup> and  
Mustafa H. Babiker<sup>\*</sup>

## Abstract

*The MIT Economic Projection and Policy Analysis (EPPA) model has been broadly applied on energy and climate policy analyses. In this paper, we provide an updated version of the model based on the most recent global economic database with the base year data of 2007. Also new in this version of the model are non-homothetic preferences, a revised capital vintaging structure, separate accounting of residences, and an improved model structure that smooths its functioning and makes future extensions easier. The study finds that, as the economies grow, the empirically observed income elasticities of demand are better represented by our setting than by a pure Stone-Geary approach, and simulation results are more sensitive to GDP growth than energy and non-energy substitution elasticities and autonomous energy efficiency improvement.*

## Contents

1. INTRODUCTION .....	2
2. THEORETICAL FRAMEWORK .....	3
2.1 Static Component .....	4
2.2 Dynamic Process .....	6
2.3 Regions, Sectors, and Backstop Technologies .....	8
2.4 Modeling Penetrations of Backstop Technologies .....	10
3. STRUCTURE .....	11
3.1 Social Accounting Matrix, Production, and Consumption .....	11
3.2 Other Improvements .....	15
4. DATA .....	15
4.1 Economics .....	15
4.2 Backstop Technologies .....	17
4.3 Energy Use and Emissions .....	19
5. REFERENCE AND POLICY SIMULATIONS .....	20
5.1 Economic Growth .....	20
5.2 GDP, Energy Use, and Emissions .....	21
5.3 Final Consumption for Food and Agricultural Products .....	24
5.4 Sensitivity Analyses .....	26
6. CONCLUSIONS .....	29
7. REFERENCES .....	30
APPENDIX A: DERIVING THE SUBSISTENCE CONSUMPTION LEVELS FOR THE STONE-GEARY SYSTEM .....	34
APPENDIX B: RECALIBRATING THE SUBSISTENCE CONSUMPTION IN LATER PERIODS .....	35
APPENDIX C: OTHER PRODUCTION STRUCTURES .....	37
APPENDIX D: REGIONAL AND SECTORIAL MAPPINGS (GTAP 8 TO EPPA6-L) .....	40
APPENDIX E: THE MODEL STRUCTURE .....	42

---

<sup>\*</sup> Joint Program on the Science and Policy of Global Change, Massachusetts Institute of Technology, MA, USA.

<sup>†</sup> Corresponding author (Email: [chenyh@mit.edu](mailto:chenyh@mit.edu))

## 1. INTRODUCTION

The MIT Economic Projection and Policy Analysis (EPPA) model is a computable general equilibrium (CGE) model of the global economy. It has been applied to the study of policy impacts on the economy and emissions, prospects for new technologies, agriculture and land use, and—in some versions—environmental feedbacks on the economy through human health and agricultural productivity.<sup>1</sup> EPPA can be run in a standalone mode, or it can be coupled with the MIT Earth System Model (MESM) to form the MIT Integrated Global System Modeling (IGSM) framework for climate policy analyses. In addition to the basic EPPA model presented in Babiker *et al.* (2001) and Paltsev *et al.* (2005), the model is usually modified to incorporate higher resolutions for some technologies or activities. Paltsev *et al.* (2014a) included detailed representations for different household transportation technologies, various sources of first generation biofuels, and land-use change; other modifications have included details for the refined oil sector, aviation sector, and health impacts from pollution.

Many of these additional features require substantial data development beyond the basic economic database. Thus, our strategy for updating EPPA6 with new underlying economic data is to first develop a lighter version of the model, and later add in details as needed for special studies. This paper presents EPPA6-L (L denotes “light”). In addition to updating the underlying economic database to a benchmark year of 2007, we revisit several key economic features, including the nature of economy-wide productivity growth, capital vintaging, and the relationship of final consumption goods to income growth. The new model provides a platform to develop economic projections to evaluate the implications of energy and climate policies; moreover, it also provides a robust platform for the ongoing model development, during which we plan to incorporate features of earlier versions of EPPA, and build additional features to study more detailed policy questions.

Careful readers will note a slight change in the EPPA name—now the *Economic Projection and Policy Analysis* model.<sup>2</sup> This reflects an increasing focus on broader global change topics including land-use change, agriculture, water, energy, air pollution, transportation, population and development. Overall, we seek to understand the linkages of the economy to the broader earth system, the implications of earth system changes for global and regional economic growth, and the implications of economic policies meant to stabilize our relationship with the planet. We start from a theoretically grounded general equilibrium representation of the world economy, and add in the necessary physical detail on resources and environmental implications of their use.

The purpose of this paper is threefold. First, we explain the improvements of EPPA6-L over EPPA5 (Paltsev *et al.*, 2014b), the previous version of EPPA, in terms of model structure, data, and assumptions. For instance, we incorporate into EPPA6-L non-homothetic preferences in modeling final consumption to better capture the observed differences in regional consumption patterns of crops, livestock, and food products. We change the vintaging structure of the model

---

<sup>1</sup> Recent examples include Jacoby and Chen (2014), Paltsev *et al.* (2014a), Karplus *et al.* (2013a), Winchester *et al.* (2013), Nam *et al.* (2013), etc. Readers may refer to the following link for details:  
<http://globalchange.mit.edu/research/publications>.

<sup>2</sup> The full name for previous versions of EPPA is the Emissions Prediction and Policy Analysis model.

to better capture the observation that the lifetimes of some capital assets have been extended substantially beyond standard depreciation schedules. We also introduce the potential for improvements in capital productivity apart from labor productivity, which allows greater flexibility in benchmarking the model to different rates of economic growth. We update the main economic data—based on the Global Trade Analysis Project Version 8 (GTAP 8) database—with a benchmark year of 2007 (Narayanan *et al.*, 2012). With the updated data we revise and update the regional business-as-usual (BAU) GDP projections according to recent studies.<sup>3</sup>

Second, we examine the performance of EPPA6-L in terms of GDP, energy use, and CO<sub>2</sub> emissions under a sample policy scenario. In particular, we compare CO<sub>2</sub> emissions from EPPA6-L and EPPA5, using EPPA5 results from the 2013 Energy and Climate Outlook (MIT Joint Program Outlook, 2013), and decompose sources that account for the different results.

Third, since an important aspect of the model’s application is to run century-scale simulations where a huge degree of uncertainty in economic growth and energy use exists, we investigate model response to changes in underlying productivity, autonomous energy efficiency improvement (AEEI), which captures non-price-driven changes in energy use over time, and the elasticity of substitution between energy and non-energy inputs, to demonstrate how different assumptions for these parameters may change emissions levels and abatement costs.

There are two caveats for the application of our model. First, the model is designed for long-term projections; as currently constructed, the model is not intended to generate or investigate short-term fluctuations due to economic business cycles or shocks to oil or agricultural markets. Second, EPPA is designed as a simulation model to study “what if” questions regarding different underlying economic or policy assumptions. It is not designed to endogenously determine an optimal policy response, or to endogenously simulate other behaviors of political actors in the face of economic and environmental change. Environmental impacts of economic activities are “external” to private economic decision making, unless specific policies are implemented to price some or all of these externalities.

Our goals with this paper are to provide an explicit documentation of a novel approach to the calibration of a large scale CGE model, including endogenous simulation of productivity growth, capital vintaging, and non-homothetic preferences, and to present a new setting that allows the model to couple with other IGSM components coherently. The rest of the paper is organized as follows: Sections 2, 3, and 4 introduce the theoretical framework, data, and structure of EPPA6-L, respectively; Section 5 analyzes simulation results for both the reference (BAU) and policy runs, and conducts sensitivity analyses with various model settings and parameterizations; and Section 6 provides conclusions and directions for future research.

## 2. THEORETICAL FRAMEWORK

EPPA6-L is a multi-region and multi-sector recursive dynamic computable general equilibrium (CGE) model of the world economy. The recursive approach suggests that production, consumption, savings and investment are determined by current period prices.

---

<sup>3</sup> See Section 4 for details.

Savings supply funds for investment, and investment plus capital remaining from previous periods forms the capital for the next period's production. EPPA6-L is solved at 5-year intervals from 2010 onward up to 2100 to generate scenarios of greenhouse gases (GHGs), aerosols, and other air pollutants emissions from human activities. Labor endowment grows at a pre-determined rate influenced by population and productivity growth rates. The model is formulated in a series of mixed complementary problems (MCP), which may include mixtures of both equations and inequalities (Mathiesen, 1985; Rutherford, 1995; Ferris and Peng, 1997). It is written and solved using the modeling languages of GAMS and MPSGE, and the latter is now a subsystem of the former (Rutherford, 1999).

## 2.1 Static Component

There are three types of agents in each region: household, producers, and government. The household owns primary factors including labor, capital, and natural resources, provides them to producers, receives income from the services they provide (wages, capital earnings and resource rents, pays taxes to the government and receives net transfers from it. In addition, household allocates income to consumption and savings.

Producers (production sectors) transform primary factors and intermediate inputs (outputs of other producers) into goods and services, sell them to other domestic or foreign producers, households, or governments, and receive payments in return. To maximize profit, each producer chooses its output level, and—under the given technology and market prices—hires a cost-minimizing input bundle. Production functions for each sector describe technical substitution possibilities and requirements.

The government is treated as a passive entity, which collects taxes from household and producers to finance government consumption and transfers.

For a typical CGE model, the activities of different agents and their interactions can be described by three types of conditions: 1) zero-profit conditions; 2) market-clearing conditions; and 3) income-balance conditions. Zero-profit conditions represent cost-benefit analyses for economic activities. For the household, economic activity is the utility; for each producer, economic activity is the output. A typical zero-profit condition expressed in MCP format is:

$$MC - MB \geq 0; Q \geq 0; [MC - MB] \cdot Q = 0 \quad (1)$$

For instance, if a zero-profit condition is applied on a production activity, then if the equilibrium output  $Q > 0$ , the marginal cost  $MC$  must equal the marginal benefit  $MB$ , and if  $MC > MB$  in equilibrium, the producer has no reason to produce. Note that  $MC < MB$  is not an equilibrium state since  $Q$  will increase until  $MC = MB$ . Other activities such as investment, imports, exports, and commodity aggregation modeled using the Armington assumption (Armington, 1969) have their own zero-profit conditions.

For each market-clearing condition, the price level is determined based on market demand and supply. A typical market-clearing condition in MCP format is:

$$S \geq D; P \geq 0; [S - D] \cdot P = 0 \quad (2)$$

The market-clearing condition states that for each market, if there is a positive equilibrium price  $P$ , then  $P$  must equalize supply  $S$  and demand  $D$ . If  $S > D$  in equilibrium, then the commodity price is zero. Similarly, in Condition (2),  $S < D$  is not in equilibrium because in this case,  $P$  will continue to increase until the market is clear ( $S = D$ ).

Income-balance conditions specify income levels of household and government that support their spending levels. A typical income-balance condition in MCP format is:

$$E \geq I; E \geq 0; [E - I] \cdot E = 0 \quad (3)$$

The expenditure  $E$  equals income  $I$  always holds in CGE models. In addition, the price of utility for the U.S. is chosen as the numeraire of the model, so all other prices are measured relative to it.

Many CGE models, including EPPA, use nested Constant Elasticity of Substitution (CES) functions with various inputs to specify preferences and production technologies. CES functions are constant return to scale (CRTS), which means if all inputs are doubled, the output will be doubled as well. Although CRTS makes solving the model easier, it suggests an income elasticity of one for all period. For instance, with food consumption, existing studies have shown that, as income grows, the expenditure shares on food consumption tend to decrease (Zhou, 2012; Haque, 2005), which suggests an income elasticity of less than one. In previous versions of EPPA, consumption shares were adjusted between periods to account for the declining share of food consumption with income growth, but the CRTS properties were kept within each period. In EPPA6-L, we take a further step toward a within-period non-homothetic preference. Our strategy is to adopt the approach presented in Markusen (2006) by applying a Stone-Geary preference system within the MPSGE framework. This system requires a shift parameter that changes the reference point of consumption from zero (as in the CES case). The shift parameter, often referred to as the subsistence consumption level, is calibrated to match estimated regional income elasticities. Note that for a set of constant shift parameters in the Stone-Geary system, income elasticities will eventually converge to one as income grows. To overcome this limitation, we recalibrate the shift parameter for each period so the income elasticities match estimated levels, even as income grows.<sup>4</sup> A caveat for this treatment is that, as in previous versions of EPPA where the consumption shares of the utility function are updated over time, the consumer's preference of EPPA6-L is recalibrated periodically.<sup>5</sup> For demonstration purposes, let us consider a utility function  $U$  with preference over  $N$  commodities indexed by  $i$ , and use  $c_i$ ,  $c_i^*$ , and  $w$  to represent consumption of commodity  $i$ , shift parameter for the consumption of commodity  $i$ , and the budget, respectively:

$$u = U(c_1 - c_1^*, c_2 - c_2^*, \dots, c_N - c_N^*) \quad (4)$$

The income elasticity for the consumption of commodity  $i$  is defined as:

$$\eta_i = \left( \frac{c_i - c_i^*}{c_i} \right) / \left( \frac{w - \sum_{i=1}^N c_i^*}{w} \right) \quad (5)$$

<sup>4</sup> See Table 6 in Section 4 for the estimated elasticities.

<sup>5</sup> This implies that the equivalent variation (EV) can only be used for measuring the within-period welfare change.

Applying the Engel's Aggregation, it can be shown (see Appendix A) that for a given  $\eta_i$ , the solution for  $c_i^*$  that satisfies Equation (5) is:

$$c_i^* = (1 - \eta_i)c_i \quad (6)$$

With Equation (6), we can calculate  $c_i^*$  for the base year (i.e., the first period, denoted by  $t = 0$ ) such that the income elasticity of demand for commodity  $i$  is  $\eta_i$ . While the same  $c_i^*$  is used for the first two periods ( $t = 0, 1$ ), for each later period  $c_i^*$  is recalibrated to approximate  $\eta_i$ . More specifically, from the third period onward ( $t \geq 2$ ), information from both the adjacent previous period ( $t - 1$ ) and the first period ( $t = 0$ ) is used to update  $c_i^*$  based on Equation (7):

$$c_{i,t}^* = x_{i,t-1}^T - y_{i,t-1}^T \cdot \frac{x_{i,t-1}^T - x_{i,0}^T}{y_{i,t-1}^T - y_{i,0}^T}; t \geq 2 \quad (7)$$

In Equation (7),  $(x_{i,0}, y_{i,0})$  is the base year consumption bundle, where  $y_i$  represents the aggregation of all commodities other than  $x_i$ , and  $(x_{i,t-1}^T, y_{i,t-1}^T)$  is the imputed consumption bundle derived from the given income elasticities and the budget  $w_{t-1}$ , while using the base year relative price level (see Appendix B for details). With this treatment, we can incorporate the existing income elasticity estimates for the final consumption of crops, livestock, and food sectors. For other EPPA sectors that cannot be directly mapped into sectors in the existing studies, we apply a uniform income elasticity level derived from the Engel's Aggregation. The details of EPPA sectors/commodities will be presented in Section 2.3.

Additional modification is required to model the food sector. Intermediate inputs of the food sector are modeled by a Leontief structure (see Appendix C), which means that, without further adjustment, crops and livestock inputs to food sector will grow proportionally as the food sector expands. We improve this representation by updating the input shares for food production activity based on final consumption trends for crops and livestock. More specifically, we update the food sector input shares such that the percentage changes of crops and livestock inputs are represented by the percentage changes of crops and livestock final consumption levels.

## 2.2 Dynamic Process

The dynamics of EPPA6-L are determined by both exogenous and endogenous factors. Exogenous factors include projections for the BAU GDP growth, labor endowment growth, factor-augmented productivity growth, autonomous energy efficiency improvement (AEEI), and natural resource assets. The data needed to calibrate the dynamics will be presented in Section 3. For each region, we assume that the labor endowment increases proportionally to population growth, subject to productivity growth adjustments. In the BAU simulation, we adjust the factor-augmented productivity levels proportionally (Hicks-neutral adjustment) to match that region's assumed BAU GDP growth profile. Since expectations of future economic growth are often in terms of GDP rather than underlying factors such as labor, land, capital, energy productivity, or resource availabilities, we have included a model feature that automatically calibrates a Hick's neutral adjustment to match a pre-specified GDP growth rate (see Section 4 for how this feature is implemented).



Dynamics determined endogenously include savings, investment, and fossil fuel resource depletion. As in previous versions of EPPA, savings and consumption are aggregated in a Leontief approach in the household's utility function. All savings are used as investment, which meets the demand for capital goods. The capital is divided into a malleable portion  $KM_t$  and a vintage non-malleable portion  $V_{n,t}$ . The dynamics of the malleable capital are described by:

$$KM_t = INV_{t-1} + (1 - \theta)(1 - \delta)^5 KM_{t-1} \quad (8)$$

In Equation (8),  $\theta$  is the fraction of the malleable capital that becomes non-malleable at the end of period  $t - 1$ , and  $INV_{t-1}$  and  $\delta$  are the investment and depreciation rate, respectively. The factor of 5 is used because the model is solved in five-year intervals. The newly formed non-malleable capital  $V_{1,t}$  comes from a portion of the survived malleable capital from the previous period:

$$V_{1,t} = \theta(1 - \delta)^5 KM_{t-1} \quad (9)$$

We have improved the vintage dynamics of EPPA6-L in two ways. Firstly, in previous versions of EPPA, once a capital stock becomes vintaged, it can only have a remaining lifespan of 20 years. While this might be a reasonable assumption for some sectors, for others (e.g. the power sector) this treatment fails to capture the much longer lifetimes of capital—some of which have been in service for decades (see Section 4 for an example). EPPA6 considers the cases where part of the vintage capital can survive beyond 20 years. Secondly, in previous versions of EPPA, we assumed that each vintage of capital depreciated. In EPPA6, we assume that physical productivity of installed vintage capital does not depreciate until it reaches the final vintage. This reflects an assumption that, once in place, a physical plant can continue to produce the same level of output without further investment. We combine this with the assumption that malleable capital depreciates continuously. Hence a physical plant can be considered to be part vintage and part malleable, with the needed updates and replacement (short of the long-term replacement of a plant) accounted in the depreciation of malleable capital.<sup>6</sup> This process can be described by:

$$V_{2,t+1} = V_{1,t}; V_{3,t+2} = V_{2,t+1}; V_{4,t+3} = V_{3,t+2} + (1 - \delta)^5 V_{4,t+2} \quad (10)$$

In the above setting,  $V_{4,t+3}$  comes not only from  $V_{3,t+2}$  but also from  $(1 - \delta)^5 V_{4,t+2}$ , which is the survived vintage capital beyond 20 years old, i.e.,  $V_{4,t+3}$  represents the sum of vintage capital stocks that are at least 20 years old. The advantage of this formulation is that we effectively extend the life to capital without the need to create in the model more vintages of capital types. Extra vintages add significantly to model complexity. We retain the formulation that in any given period  $t$ , there are always only four classes of vintage capital  $V_{1,t}$ ,  $V_{2,t}$ ,  $V_{3,t}$ , and  $V_{4,t}$  but the

---

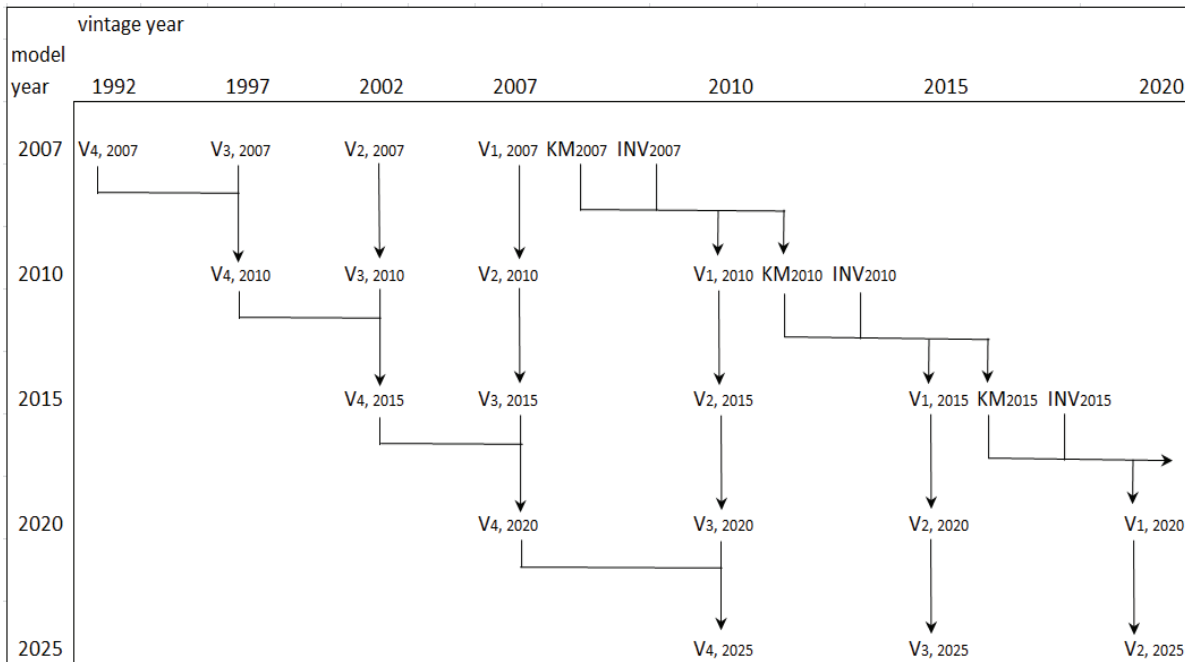
<sup>6</sup> This is a heuristic explanation. Malleable capital can be redeployed anywhere in the economy, but a long-lived investment such as a power plant structure or factory building that may last for 30, 40, 50 years or more requires various additional investment over that period to remain functional. The formulation used here simplifies reality to retain computational feasibility while capturing the essence of capital lock-in, with the need for ongoing maintenance investment. In an equilibrium solution, the rental price of old capital may fall to zero, implying that it is not used, or is only partly used (see Morris *et al.*, 2014 for a discussion and example simulations).

effective lifetime of capital is 25 years (the 5-year life of the initial malleable stock, plus the 5-year time step for each of the four explicit vintages) plus the half life of the final vintage.<sup>7</sup>

**Figure 1** demonstrates the dynamics for capital stock evolution presented graphically in (8), (9), and (10). To better illustrate the idea, we put “model year” and “vintage year” as the vertical and horizontal axes, respectively, with the former denoting the time period of the model and the latter representing the year when the vintage capital is formed. Therefore,  $V_{3,2020}$  for the model year of 2020 was formed in the year 2010. The fact that  $V_{4,2025}$  comes from both  $V_{3,2020}$  and the survived  $V_{4,2020}$  gives an example for the formulation of (10). Vintage capital  $V_{n,t}$  is sector specific, and while factor substitution in response to change in relative price is possible for the malleable portion, it is not possible for the non-malleable portion.

To capture the long-run dynamics of fossil fuel prices, fossil fuel resources  $R_{e,t}$  are subject to depletion based on their annual production levels  $F_{e,t}$  at period  $t$ . Values of  $F_{e,t}$  are then multiplied by a factor of five to approximate depletion in intervening years, to align with the five-year time step:

$$R_{e,t+1} = R_{e,t} - 5F_{e,t} \quad (11)$$



**Figure 1.** Dynamics for capital stock evolution.

### 2.3 Regions, Sectors, and Backstop Technologies

EPPA6-L disaggregates the global economy into 18 regions, as shown in **Table 1**. While most of the regions are the same as its predecessor, EPPA6-L identifies South Korea and Indonesia separately from the aggregated ASI region of EPPA5, to reflect the increasing importance of their economic activities and GHGs emissions in the global economy. Regarding sectors of the

<sup>7</sup> The half life with an annual depreciation rate of 5% used in EPPA is around 15 years.

model, shown in **Table 2**, in EPPA6-L we separate Ownership of Dwellings from EPPA5's Other Industries sector. With this treatment, we are able to better represent the household's energy consumption for heating or cooling. In particular, this makes energy use complementary with expansion of dwellings. While there is the possibility to substitute other inputs for energy within dwellings through investment, for example, in more efficient heating, ventilation, and air-conditioning (HVAC) systems or more efficient building design, general scaling up of the dwelling sector (with increases of population and income) requires proportionally more energy, unless energy prices rise and stimulate substitution.

Based on engineering data (see Section 4 for details), we consider “backstop technologies”—new or alternative technology options not presented explicitly in GTAP 8—as shown in **Table 3**. To produce the same outputs as those from current technologies, backstop technologies are usually more expensive to operate in the base year. Because of this, most backstop technologies have not run at commercial scales or have not operated at all so far, but they may become economic in the future pending changes such as higher fossil fuel prices or policy interventions. The MCP formulation presented in Section 2 allows no output from a backstop technology if it is not economic to operate. Some backstop technologies in Table 3 have been run at nontrivial scales since 2007 (mostly due to incentives or support provided by the government), including wind power, solar power, first generation biofuels, and bio-electricity. We calibrate the model so for historical runs (years 2007 and 2010), the output levels of these technologies match those of the World Energy Outlook from the International Energy Agency (IEA, 2012).

**Table 1.** Regions in EPPA6-L.

Region	EPPA6-L	EPPA5
United States	USA	USA
Canada	CAN	CAN
Mexico	MEX	MEX
Japan	JPN	JPN
Australia, New Zealand & Oceania	ANZ	ANZ
European Union <sup>8</sup>	EUR	EUR
Eastern Europe and Central Asia	ROE	ROE
Russia	RUS	RUS
East Asia	ASI	ASI
South Korea	KOR	ASI
Indonesia	IDZ	ASI
China	CHN	CHN
India	IND	IND
Brazil	BRA	BRA
Africa	AFR	AFR
Middle East	MES	MES
Latin America	LAM	LAM
Rest of Asia	REA	REA

<sup>8</sup> The European Union (EU-27) plus Croatia, Norway, Switzerland, Iceland and Liechtenstein.

**Table 2.** Sectors in EPPA6-L.

Sector	EPPA6-L	EPPA5
Agriculture - Crops	CROP	CROP
Agriculture - Livestock	LIVE	LIVE
Agriculture - Forestry	FORS	FORS
Food Products	FOOD	FOOD
Coal	COAL	COAL
Crude Oil	OIL	OIL
Refined Oil	ROIL	ROIL
Gas	GAS	GAS
Electricity	ELEC	ELEC
Energy-Intensive Industries	EINT	EINT
Other Industries	OTHR	OTHR
Ownership of Dwellings	DWE	OTHR
Services	SERV	SERV
Transport	TRAN	TRAN

**Table 3.** Backstop technologies in EPPA6-L.

Backstop Technology	EPPA6-L
First generation biofuels	bio-fg
Second generation biofuels	bio-oil
Oil shale	synf-oil
Synthetic gas from coal	synf-gas
Hydrogen	h2
Advanced nuclear	adv-nucl
IGCC w/ CCS	igcap
NGCC	ngcc
NGCC w/ CCS	ngcap
Wind	wind
Bio-electricity	bioelec
Wind power combined with bio-electricity	windbio
Wind power combined with gas-fired power	windgas
Solar generation	solar

## 2.4 Modeling Penetrations of Backstop Technologies

To model the penetration of a backstop technology, previous versions of EPPA have adopted a “technology-specific factor” that is required to operate the backstop technology, but may only be available in limited supply—especially when the technology is in its earlier stage of introduction. The resource rent of the technology-specific factor goes to the representative household, which is the owner of that factor.

Parameterizing the supply of a technology-specific factor for backstop technologies is challenging, as very often those technologies have not yet entered the market. Recent work by Morris *et al.* (2014) provides a theoretical framework to improve the representation of backstop penetration. Morris *et al.* sought a theoretically-based formulation that captures key observations of technology penetration (e.g. gradual penetration, falling costs) that could be parameterized based on observations.

In short, Morris *et al.* argues that when demand for the output of the backstop technology increases over time, the investment for operating the backstop technology goes up, and so does the supply of technology-specific factor, which may eventually become a nonbinding input for the operation of the backstop technology. The study parameterizes the technology-specific factor supply by the analogue of nuclear power expansion in the U.S. from its introduction in the late 1960's to the mid-80's.

More specifically, Morris *et al.* argues that during that period when nuclear power was expanding, it was regarded as the next-generation technology poised to take over most of the base load generation; therefore, the experience of nuclear power expansion may provide a good approximation for representing the expansions of other new technologies. Thus, to model the penetrations of backstop technologies in EPPA6-L, we incorporate the settings and empirical findings of Morris *et al.* into our model:

$$bbres_{bt,t+1} = \alpha \cdot [bout_{bt,t} - (1 - \delta)^5 \cdot bout_{bt,t-1}] + \beta \cdot [bout_{bt,t}^2 - (1 - \delta)^5 \cdot bout_{bt,t-1}^2] + bbres_{bt,t} \cdot (1 - \delta)^5 \quad (12)$$

In Equation (12),  $bbres_{bt,r,t}$  is the supply of technology-specific factor for technology  $bt$  in period  $t$ , and  $bout_{bt,t}$  is the output of  $bt$  in period  $t$ . The estimates from Morris *et al.* are  $\alpha = 0.9625$  and  $\beta = 1.3129 \cdot 10^{-7}$ .<sup>9</sup> Morris *et al.* also specifies a value of 0.3 for the benchmark substitution elasticity between the technology-specific factor and other inputs, and this is also adopted in EPPA6-L.

### 3. STRUCTURE

#### 3.1 Social Accounting Matrix, Production, and Consumption

A social accounting matrix (SAM) contains the base year input-output and supply-demand structures of the economy. It provides a consistent picture of production activities, market transactions, and income-expenditure flows between different agents in the economy. **Table 4** provides the structure for the SAM of each region in EPPA6-L, which is constructed based on the micro-consistent format of SAM presented in Rutherford (1999)—each row corresponds to a market-clearing condition (Condition 2 in Section 2), and columns characterize the zero-profit condition of an activity (Condition 1 in Section 2), except for the last column which represents the income-balance condition of the economy (Condition 3 in Section 2). Variables in blue/italic denote output of each activity, supply of each market, or endowment of the representative agent (those in the last column); variables in red are input of each activity, demand of each market, or aggregate consumption of the representative agent (those in the last column). To keep the symbols clean, sectorial and regional indices of each variable are dropped.

Domestic production activities are presented in Columns 1–3, where  $XP0$ ,  $N\_E0$ , and  $H\_E0$  denote outputs by sectors  $d$  (all sectors except for nuclear and hydro power),  $n\_e$  (nuclear

<sup>9</sup> The very small estimate for  $\beta$  suggests that the quadratic terms indeed play much less roles in the accumulation of technology-specific factor.

power), and  $h_e$  (hydro power), respectively.  $XDP0$ ,  $N_{S0}$ , and  $H_{S0}$  are energy and non-energy inputs from domestic production, and  $XMP0$ ,  $N_{OT0}$ , and  $H_{OT0}$  are imported energy and non-energy inputs. Domestically produced and imported inputs are aggregated together by the Armington assumption.  $LABD$ ,  $N_{L0}$ , and  $H_{L0}$  are labor inputs;  $KAPD$ ,  $N_{K0}$ , and  $H_{K0}$  are capital inputs; and  $FFACTD$ ,  $N_{R0}$ , and  $H_{R0}$  are other resource inputs. When CO<sub>2</sub> emissions are priced, the carbon penalty will be reflected by higher prices for energy inputs. For sectors (CROP and EINT) with CO<sub>2</sub> emissions related to production rather than energy consumption, the carbon penalty for emission levels  $OUTCO2$  becomes a necessary input. Lastly,  $TD$ ,  $TI$ , and  $TF$  are taxes on output, intermediate input, and primary input, respectively.

Columns 4–6 are for activities of capital formation  $inv$ , international transportation service  $yt$ , and household transportation ( $htrn$ ). The inputs of capital formation include  $XDI0$  (domestic produced inputs) and  $XMI0$  (imported inputs) with the output  $INV0$ , which becomes part of next period's capital stock. The regional input for international transportation service is denoted by  $VST$ , while the output is  $\Sigma VST$ . Household transportation  $TOTTRN$  includes the service from privately owned vehicles (which needs inputs from the service sector  $TSE$ , from the other sector  $TOI$ , and from the refined oil sector  $TRO$ ), and the service from the purchased transportation  $PURTRN$ . Taxes paid by this activity is denoted by  $TP$ . Columns 7–12 are activities for adding carbon and GHGs penalties to the consumer prices of various energy consumptions. In these columns,  $EIND$ ,  $EUSEP$ , and  $\varepsilon$  are sectorial energy use without a carbon penalty, sectorial energy use with a carbon penalty, and emissions coefficient, respectively. Similarly, we have  $HEFD$  and  $TEFD$  for household non-transport energy use and household transport energy use, both carbon penalty excluded.  $HEUSEF$  and  $TEUSEF$ , on the other hand, denote the same types of energy use with carbon penalty included.

Column 13–16 are activities for Armington aggregation  $a$ , trade  $m$ , total household consumption  $z$ , and welfare (utility) function  $w$ , respectively. Armington output  $A0$  is the aggregation of domestic produced product  $D0$  and imports  $XM0$ , and the latter comes from exports of other regions  $WTFLOW$  plus the international transportation service  $\Sigma VTWR$ , which is the same as  $\Sigma VST$ . Total household consumption  $CONS0$  includes Armington goods (the sum of  $XDC$  (domestic produced commodities) and  $XMC$  (imported commodities), household transportation  $TOTTRN$ , and non-transportation energy consumption  $ENCE$ ). Household utility  $W0$  is derived from consumption  $CONS0$  and saving  $INV0$ .

The government activity  $govt$  represents how the government's Armington consumption (sum of domestic produced commodities  $XDG0$  and imported commodities  $XMG0$ ) and the associated tax payment  $TG$  are converted into the government output  $G0$ . Column 19 is for the income balance condition of the representative household  $ra$ . The total (gross) household income is constituted of net labor income  $LABOR$ , net capital income  $CAPITAL$ , resource rents including  $FFACT$ ,  $N_R$ ,  $H_R$ , and the tax payment  $GRG$ , while the household expenditure is allocated to purchasing utility  $w0$  and spending on government output  $GRG$ , which is exogenously determined and is assumed to increase proportional to GDP growth since the government is treated as a passive entity in EPPA.

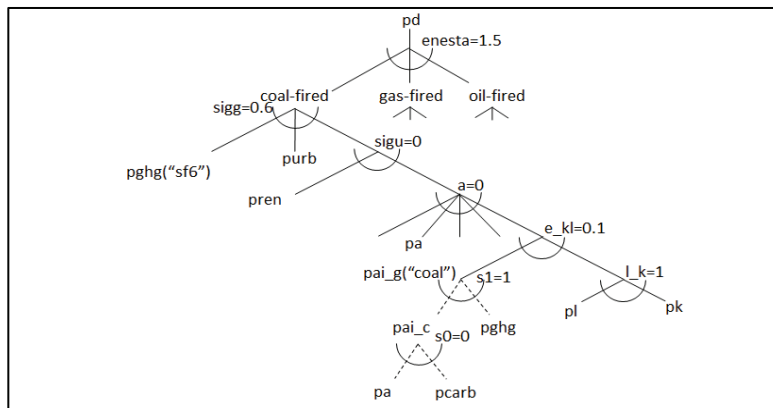
Table 4. Social accounting matrix of EPPA6-L.

		Activities and their corresponding Zero-profit Conditions																Household Income-balance Conditions			
		Domestic Production				Int'l. Transp. Service		HH Transp.		Carbon and GHG Penalties				Armington Aggregation						Govt. Activity	
		<i>d</i>	<i>n_e</i>	<i>h_e</i>	<i>inv</i>	<i>yt</i>	<i>htrn</i>	<i>eid</i>	<i>eid_ghg</i>	<i>efd_ghg</i>	<i>tefd_ghg</i>	<i>edf</i>	<i>tedf</i>	<i>a</i>	<i>m</i>	<i>z</i>	<i>w</i>			<i>govt</i>	<i>ra</i>
Domestic Production	<i>pd</i>	<i>N_E0</i>	<i>H_E0</i>	<i>inv</i>	<i>VST</i>							<i>D0</i>	<i>WTFLOW</i>								
Loanable Funds	<i>pinv</i>			<i>INV0</i>												<i>INV0</i>					
Intl. Transp.	<i>pt</i>				$\Sigma VST$									$\Sigma VTWR$							
HH Transp.	<i>ptrn</i>				<i>TOTTRN</i>									<i>TOTTRN</i>							
	<i>pal_c</i>					<i>EUSEP</i>	<i>EUSEP</i>	<i>EUSEP</i>													
	<i>pal_g</i>	<i>XDPO + XMP0</i>				<i>EUSEP</i>	<i>EUSEP</i>	<i>EUSEP</i>													
	<i>paf_g</i>						<i>HEUSEF</i>	<i>HEUSEF</i>													
Armington Goods	<i>paf_gh</i>				<i>TRO</i>		<i>HEUSEF</i>	<i>HEUSEF</i>							<i>ENCE</i>						
	<i>paf_c</i>						<i>HEUSEF</i>	<i>HEUSEF</i>													
	<i>paf_ch</i>						<i>HEUSEF</i>	<i>HEUSEF</i>													
	<i>pa</i>	<i>XDPO + XMP0</i>	<i>N_S0; N_OT0</i>	<i>XDIO + XMIO</i>	<i>TOI; TSE; PURTRN</i>	<i>EUSEP</i>	<i>HEUSEF</i>	<i>HEUSEF</i>	<i>TEUSEF</i>	<i>TEUSEF</i>	<i>TEUSEF</i>	<i>A0</i>	<i>XDC + XMC</i>	<i>XDG0 + XMIG0</i>							
Imports	<i>pm</i>											<i>XMO XM0</i>	<i>CONSO</i>	<i>CONSO</i>							
Total HH Consump.	<i>pu</i>																				
Utility	<i>pw</i>															<i>W0</i>		<i>W0</i>			
	<i>pl</i>	<i>LABD</i>	<i>N_L0</i>	<i>H_L0</i>														<i>LABOR</i>			
	<i>pk</i>	<i>KAPD</i>	<i>N_K0</i>	<i>H_K0</i>														<i>CAPITAL</i>			
Primary Factors	<i>pf</i>	<i>FFACTD</i>																<i>FFACT</i>			
	<i>pr</i>		<i>N_R0</i>															<i>N_R</i>			
	<i>pr_h</i>			<i>H_R0</i>														<i>H_LR</i>			
Government Expenditure	<i>pg</i>																<i>G0</i>	<i>-GRG</i>			
Emissions Constraints	<i>pcarb</i>	<i>OUTCO2</i>				<i>EIND*ε</i>	<i>HEFD*ε</i>	<i>TEFD*ε</i>										<i>CARBIM</i>			
Resources for Tax Payment	<i>tax</i>	<i>TD; Ti; TF</i>	<i>TD; Ti; TF</i>	<i>TD; Ti; TF</i>	<i>TP</i>							<i>TX; TM</i>	<i>TP</i>	<i>TG</i>				<i>GRG</i>			

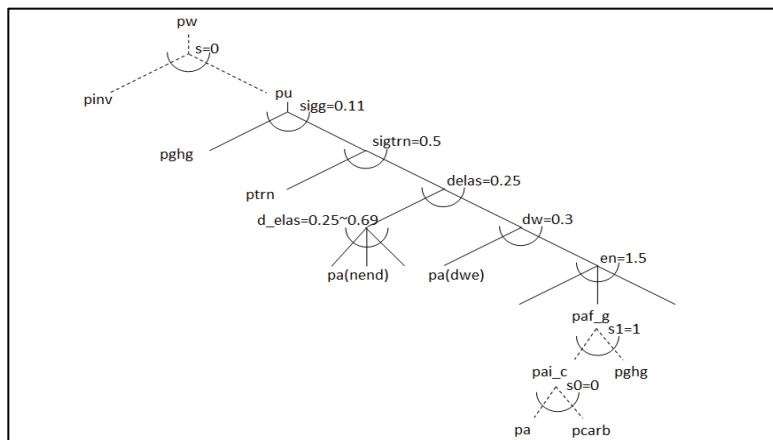
Market-clearing Conditions

On the other hand, Rows 1–4 are market clearing conditions for domestic production, loanable fund, international transportation, and household transportation, respectively. Rows 5–11 are market clearing conditions for Armington goods, Rows 12–14 are market clearing conditions for imports, total household consumption, and utility, respectively. Rows 15–19 are market clearing conditions for primary factors (labor, capital, and natural resources), Row 20 and Row 21 are market clearing conditions for government service and emissions constraint, respectively, and Row 22 presents the resource for tax payment *GRG* and where it goes.

The CES production and preference structures of EPPA6-L are presented in **Figure 2** and **Figure 3**, respectively. In Figure 2, we take the fossil-based generation as an example, and show how various inputs are aggregated in a nested fashion to represent the generation technology. Components in dashed line denote separate functions. Production structures for other sectors are provided in Appendix C. Note that while factor substitution in response to change in relative price is possible for malleable production (production activities using malleable capital), that is not the case for vintage production (production activities using non-malleable capital), i.e., in our model, for each sector, the nest structure for vintage production becomes Leontief. Figure 3 provides the setting for the utility function. In a recursive dynamic framework, savings enter the utility as they can expand the capacity of future production and eventually raise future consumption levels.



**Figure 2.** Production structure for fossil-based generation.



**Figure 3.** Utility function.



## 3.2 Other Improvements

In addition to new features documented in Section 2, a variety of “under-the-hood” improvements were made that smooth the functioning of EPPA6 and make editing and changes easier with less chance of introducing errors. Among them are:

- **Simplified model structure.** We eliminated separate but mostly repeated codes related to the reference and policy runs. There is now a single code for running both. This simplification reduces chances of programming errors in future model development.
- **Endogenously calibrated Hick’s neutral productivity levels.** In EPPA6-L, BAU GDP growth rates can be specified directly and the model will impute Hick’s neutral productivity levels at values needed to produce the specified path of GDP growth. After the productivity levels are calculated, for the same reference scenario, the model will replicate the same GDP growth patterns under the given productivity levels.
- **Explicit treatment for value-added taxes.** In previous versions of EPPA, value-added taxes were combined with the net factor income. In EPPA6-L, net factor income and value-added taxes are separated so both are presented explicitly. This treatment facilitates studies on tax reform or double dividend issues.
- **Improved model solution.** Solution information is saved to provide an advanced basis for solving the model again in the future, using the “savepoint” feature of GAMS (McCarl et al., 2014). It is worth noting that while the feature speeds up the process of finding solutions in most applications, the downside of it is that sometimes using the solution information from the previous run may slow convergence with substantial changes for some parameter values (such as BAU GDP growth rates). To avoid this, the feature can be turned off when necessary.
- **Ability to stop and restart the model at any intermediate period.** With this feature, once the restart information is generated for previous time periods, one may choose to rerun the model from any intermediate period, if there have been no changes in the model setting for earlier periods. This feature facilitates the incorporation of feedbacks from other models when, for example, EPPA6-L is coupled with other earth system components of IGSM.<sup>10</sup>

Details for the structure of EPPA6-L and the roles of different model components are provided in Appendix E.

## 4. DATA

### 4.1 Economics

The main economic data used in EPPA6-L is GTAP 8, the latest GTAP database with the base year 2007 when the study is finished. GTAP 8 classifies the global economy into 129 regions, 57

---

<sup>10</sup> We appreciate inputs from Tom Rutherford on the improved model solution feature, and contributions by Tom Rutherford and Qudsia Ejaz on the feature allowing the model to stop and restart at any intermediate period.

sectors (commodities) and 5 types of production factors (GTAP, 2013). For each sector in each region, the database provides information such as bilateral trade and input-output structure—key inputs for a global CGE model. While the original GTAP 8 data are at a lower level of aggregation, for efficiency and feasibility considerations, global CGE models are often run at more aggregated levels. EPPA6-L aggregates the GTAP 8 regions, sectors, and production factors into 18 regions (see Table 1), 14 sectors (see Table 2), and 4 factors (labor, capital, land, and natural resources). The mapping details for regions, sectors, and production factors from GTAP 8 to EPPA6-L are provided in **Table D1** to **Table D3** in Appendix D.

In a CES function, the elasticity of substitution specifies the extent to which one input can be substituted for by others under a given level of output when the relative price of inputs changes. The Armington aggregation for imported and domestic products uses a CES function, and the elasticity of substitution between domestic and imported products controls the degree to which products differ. In a production activity that uses fossil fuel and others as inputs, the substitution elasticity between fossil fuel and other inputs determines to what level the fossil fuel use can be replaced by other inputs if the price of fossil fuel increases.

Similarly, the elasticity of substitution in a utility function characterizes consumer preference (i.e., the substitution possibility between various consumption goods when facing a price change). As shown in **Table 5**, EPPA6-L draws the elasticities of substitution from its predecessor. The elasticity values are based on literature review. While sensitivity analyses using various elasticity values have been conducted extensively using earlier versions of EPPA (Cossa, 2004; Webster *et al.*, 2002), in this study, we will take the substitution elasticity between energy and non-energy inputs as given, and demonstrate how sensitive CO<sub>2</sub> emissions and prices are affected by different elasticity levels.

For a dynamic CGE applied to long-term projections, the inter-temporal calibration of regional BAU GDP growth is crucial. For this work, our first step is to incorporate near-term GDP growth projections in the World Economic Outlook (IMF, 2013) which run through 2018. For later years, the projections of Paltsev *et al.* (2005) offer starting points, adjusted to reflect long term regional GDP from recent studies, including the World Bank (2013), United Nations (2013), Gordon (2012), and Empresa de Pesquisa Energética (EPE) (2007). For instance, we raise Africa's BAU GDP growth projection beyond 2020 to account for increased population growth projection published by the United Nations. We incorporate the income elasticity estimates for the final consumption levels of CROP, LIVE, and FOOD based on Reimer and Hertel (2004), which was the estimation for An Implicit Direct Additive Demand System (AIDADS). Since the study of Reimer and Hertel was conducted before the base year of our model, we adjust those elasticities to those given in **Table 6**, which are functions of income and price levels, to account for changes in economic environment.<sup>11</sup>

---

<sup>11</sup> Reimer and Hertel (2004) uses the GTAP5 database, which has the base year of 1997.

**Table 5.** Substitution elasticities in EPPA6-L.

Type of substitution elasticity	Notation	Value
between domestic and imported goods	sdm	1.0–3.0
between imported goods	smm	0.5–5.0
between energy and non-energy (labor-capital bundle) inputs	e_kl	0.6–1.0
between labor and capital	l_k	1.0
between electricity and fossil energy bundle for the aggregated energy	noe_el	0.5
between fossil energy inputs for the fossil energy bundle	esube	1.0
between conventional fossil generations	enesta	1.5
between natural resource and other inputs	esup	0.3–0.5

Source: Cossa (2004)

**Table 6.** Income elasticity for agricultural and food products.

	CROP	LIVE	FOOD		CROP	LIVE	FOOD
USA	0.08	0.65	0.67	CHN	0.65	1.01	0.88
CAN	0.13	0.61	0.62	IND	0.58	1.11	0.88
MEX	0.50	0.71	0.70	BRA	0.58	0.78	0.75
JPN	0.18	0.60	0.61	AFR	0.63	1.05	0.89
ANZ	0.22	0.59	0.60	MES	0.63	0.83	0.80
EUR	0.16	0.60	0.61	LAM	0.63	0.82	0.79
ROE	0.63	0.82	0.79	REA	0.54	1.16	0.87
RUS	0.56	0.76	0.74	KOR	0.30	0.61	0.61
ASI	0.64	0.86	0.81	IDZ	0.67	1.00	0.88

Source: Reimer and Hertel (2004); with adjustments for changes in prices and income levels

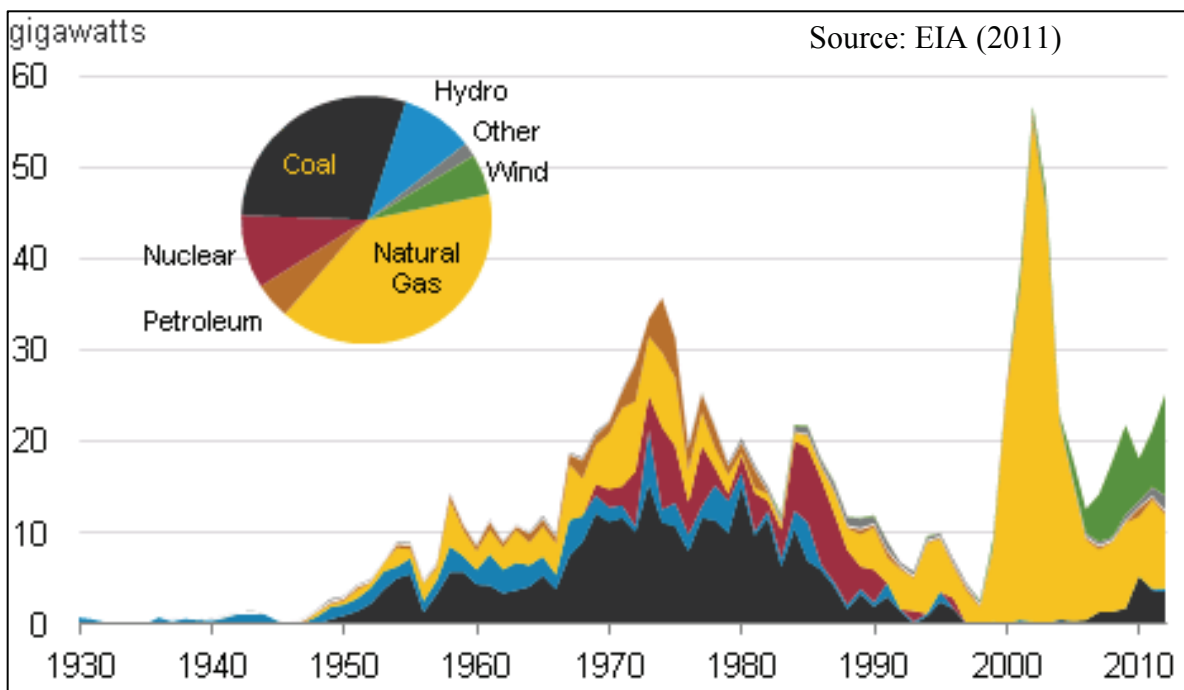
## 4.2 Backstop Technologies

As in previous versions of EPPA, for each backstop technology we use a “markup” factor to characterize the economics of that technology in the base year. The markup is defined as the ratio of the backstop technology’s production cost to that of the technology that currently produces the same product. For instance, if a backstop technology has a markup value of 1.2, then in the base year it is 20% more expensive to operate than the current technology. Markups are derived from the engineering data for backstop technologies. For non-power sector backstop technologies (oil shale, synthetic gas from coal, hydrogen, first generation biofuels, second generation biofuels), the markups are derived from Gitiaux *et al.* (2012) and the previous version of EPPA with adjustments for changes in price levels for the 2007 benchmark data from the 2004 level.

Before discussing the markups for power sector backstop technologies, it is worth noting that power plants in duty have often been built decades ago. Taking the power sector in the U.S. for instance, as shown in **Figure 4**, around three-quarters of the coal-fired capacity has been in operation for at least 30 years (EIA, 2011). In terms of the levelized cost, existing coal-fired power plants may be cheaper to operate than those that will adopt the newest designs since in the earlier years, it was easier and faster to get the coal-fired power projects approved—there were fewer environmental considerations, and the emissions standards were less stringent as well. In

the earlier versions of EPPA, markups for power sector backstop technologies were derived by comparing the levelized costs of backstop technologies to that of a planned new coal-fired power unit (which will likely be more expensive to operate than existing coal-fired power plants), and hence did not consider the potential cost difference between new and existing coal fire units, suggesting that markups for power sector backstop technologies could have been underestimated.

To account for this, for power sector backstop technologies (see Table 3 in Section 2 for details), instead of benchmarking on a new coal-fired power unit, we calculate their markups based on the existing coal-fired power plant. To represent the levelized cost of electricity generation for an existing “average” coal-fired power plant, we use the overnight capital cost data from Bechtel Power Corporation (1981). All costs represented in the base year situation (levelized capital cost, operating and maintenance (O&M) cost, and fuel costs) are adjusted to the 2007 price levels, and we use a seven-year average of fuel costs based on EIA (2013a) to avoid the short-term fluctuation of energy prices. In **Table 7**, the engineering data for backstop technologies are based on EIA (2010). As the third column of Table 7 shows, in terms of the levelized cost, a new coal-fired unit is around 8% more expensive to operate compared to the existing unit. Markups for different power sector backstop technologies are also presented in that table. For each technology, the markup and cost structure are used to calibrate the cost function, and through the zero-profit condition presented in Section 2, the output can also be determined.



**Figure 4.** Power sector capacity additions in the U.S.

**Table 7.** Markups for power sector backstop technologies.

	Pulverized Coal (Built in 1980)	Pulverized Coal (New)	NGCC	NGCC with CCS	IGCC with CCS	Advanced Nuclear (EIA Numbers)	Wind	Biomass	Solar Thermal	Solar PV	Wind Plus Biomass Backup	Wind Plus NGCC Backup
<b>“Overnight” Capital Cost</b> \$/KW	1775	2196	956	1909	3731	3774	1942	3803	5070	6097	5745	2899
<b>Total Capital Requirement</b> \$/KW	2059	2548	1033	2138	4477	5284	2098	4411	5476	6584	6205	3131
<b>Capital Recovery Charge Rate</b> %	10.6%	10.6%	10.6%	10.6%	10.6%	10.6%	10.6%	10.6%	10.6%	10.6%	10.6%	10.6%
<b>Fixed O&amp;M</b> \$/KW	27.81	27.81	11.82	20.11	46.58	90.93	30.61	65.03	57.30	11.79	95.64	42.42
<b>Variable O&amp;M</b> \$/KWh	0.005	0.005	0.002	0.003	0.004	0.001	0.000	0.007	0.000	0.000	0.007	0.002
<b>Project Life</b> years	20	20	20	20	20	20	20	20	20	20	20	20
<b>Capacity Factor</b> %	85%	85%	85%	80%	80%	85%	35%	80%	35%	26%	42%	42%
<b>Capacity Factor Wind</b> %											35%	35%
<b>Capacity Factor Biomass/NGCC</b> %											7%	7%
<b>Operating Hours</b>	7446	7446	7446	7008	7008	7446	3066	7008	3066	2278	3679	3679
<b>Capital Recovery Required</b> \$/KWh	0.0292	0.0362	0.0147	0.0322	0.0675	0.0750	0.0723	0.0665	0.1887	0.3055	0.1782	0.0899
<b>Fixed O&amp;M Recovery Required</b> \$/KWh	0.0037	0.0037	0.0016	0.0029	0.0066	0.0122	0.0100	0.0093	0.0187	0.0052	0.0260	0.0115
<b>Heat Rate</b> BTU/KWh	8740	8740	6333	7493	8307	10488	0	7765	0	0	7765	6333
<b>Fuel Cost</b> \$/MMBTU	3.15	3.15	8.18	8.18	3.15	0.50	0.00	2.61	0.00	0.00	2.61	8.18
<b>Fraction Biomass/NGCC</b> %											8.8%	8.2%
<b>Fuel Cost</b> \$/KWh	0.03	0.03	0.05	0.06	0.03	0.01	0.00	0.02	0.00	0.00	0.00	0.00
<b>Levelized Cost of Electricity</b> \$/KWh	0.07	0.07	0.07	0.10	0.11	0.09	0.08	0.10	0.21	0.31	0.21	0.11
<b>Transmission and Distribution</b> \$/KWh	0.02	0.02	0.02	0.02	0.02	0.02	0.02	0.02	0.02	0.02	0.03	0.03
<b>Cost of Electricity</b> \$/KWh	0.09	0.09	0.09	0.12	0.13	0.11	0.10	0.12	0.23	0.33	0.24	0.14
<b>Markup / New Pulverized Coal</b>	0.92	1.00	0.98	1.34	1.43	1.23	1.11	1.33	2.47	3.59	2.64	1.50
<b>Markup / Coal built in 1980</b>	1.00	1.08	1.06	1.44	1.55	1.33	1.20	1.44	2.67	3.89	2.85	1.62

Sources: EIA (2010) and Bechtel Power Corporation (1981); with adjustments for changes in prices

### 4.3 Energy Use and Emissions

While GTAP 8 has included energy use data from IEA (Narayanan *et al.*, 2012), we incorporate IEA’s recent updates by recalibrating the historical energy use in the model based on the World Energy Outlook (IEA, 2012a). We also use IEA’s data of combusted CO<sub>2</sub> emissions associated with energy consumption (IEA, 2012b). For CO<sub>2</sub> emissions related to cement production, which accounts for around 4.5% of global non-land-use-related CO<sub>2</sub> emissions, we draw the data from Boden *et al.* (2010). In EPPA6-L, CO<sub>2</sub> emissions related to land-use change are exogenously specified based on the RCP8.5 (Riahi *et al.*, 2007). An important near-term direction for expanding EPPA6 is to incorporate land use change and emissions coefficients associated with change such that land use emissions are endogenous as in previous EPPA versions (e.g. see Gurgel *et al.*, 2007).

EPPA6-L also considers non-CO<sub>2</sub> GHG emissions and urban pollutant emissions. The non-CO<sub>2</sub> GHGs included in the model are: methane (CH<sub>4</sub>), perfluorocarbon (PFC), sulfur hexafluoride (SF<sub>6</sub>), and hydrofluorocarbon (HFC); the urban pollutants considered are carbon monoxide (CO), volatile organic compound (VOC), nitric oxide and nitrogen dioxide (NO<sub>x</sub>), sulfur dioxide (SO<sub>2</sub>), black carbon (BC), organic carbon (OC), and ammonia (NH<sub>3</sub>). Most of the base year non-CO<sub>2</sub> GHGs and urban pollutants are drawn from the Emissions Database for Global Atmospheric Research (EDGAR) Version 4.2 (European Commission, 2013).<sup>12</sup> Two exceptions are BC and OC, which are based on Bond (2000).

For later years, energy use levels are determined endogenously by factors such as the patterns of economic growth, technological change (both AEEI and price-driven), and relevant energy or emissions policies. In EPPA6-L, we include a 1% per year of AEEI improvement for all other sectors except for the power sector.<sup>13</sup> We assume a 0.3% per year of AEEI improvement for power sector as previous EPPA, which leads to an efficiency of conversion from fuels to electricity that approaches 0.5 by the end of the century in the BAU scenario. Energy use levels also determine the remaining fossil fuel reserves. In EPPA6-L, estimates for oil, gas, and coal resources are from previous versions of EPPA. Details are provided in Paltsev *et al.* (2005). We incorporate the revised outlook for the growing output of shale gas production due to the technology breakthrough that makes the extraction of shale resources more economically feasible (EIA, 2013; Jacoby *et al.*, 2012; Paltsev *et al.*, 2011).

## 5. REFERENCE AND POLICY SIMULATIONS

In EPPA6-L, the regional BAU GDP growth projections have been revised, and the changes will in turn affect the CO<sub>2</sub> emissions through energy consumption, as described in this section. Since the introduction of Stone-Geary preference on food consumption is new to the model, we compare results between food consumption levels with the Stone-Geary preference and those without that. Lastly, we provide sensitivity analyses on CO<sub>2</sub> emissions and CO<sub>2</sub> prices under various growth assumptions, AEEI levels, and elasticities of substitution between energy use and capital-labor bundle.

### 5.1 Economic Growth

The near-term regional GDP growth projections in the IMF's World Economic Outlook (see Section 4 for details) are generally higher than the EPPA5 numbers before 2020, and therefore, the global GDP growth projections for the next decades are increased, as shown in **Figure 5a**. For years around the middle of the century, projections for the global GDP growth rates are somewhat lower than those of EPPA5 due to reduced GDP growth projections for developed regions, including USA and EUR, and for the last half of the 21<sup>st</sup> century, the global GDP growth rates eventually approximate EPPA5's levels because of the higher growth in AFR. Under the new projection, the global GDP level for 2020 is 3.8% higher than that of EPPA5, and the levels

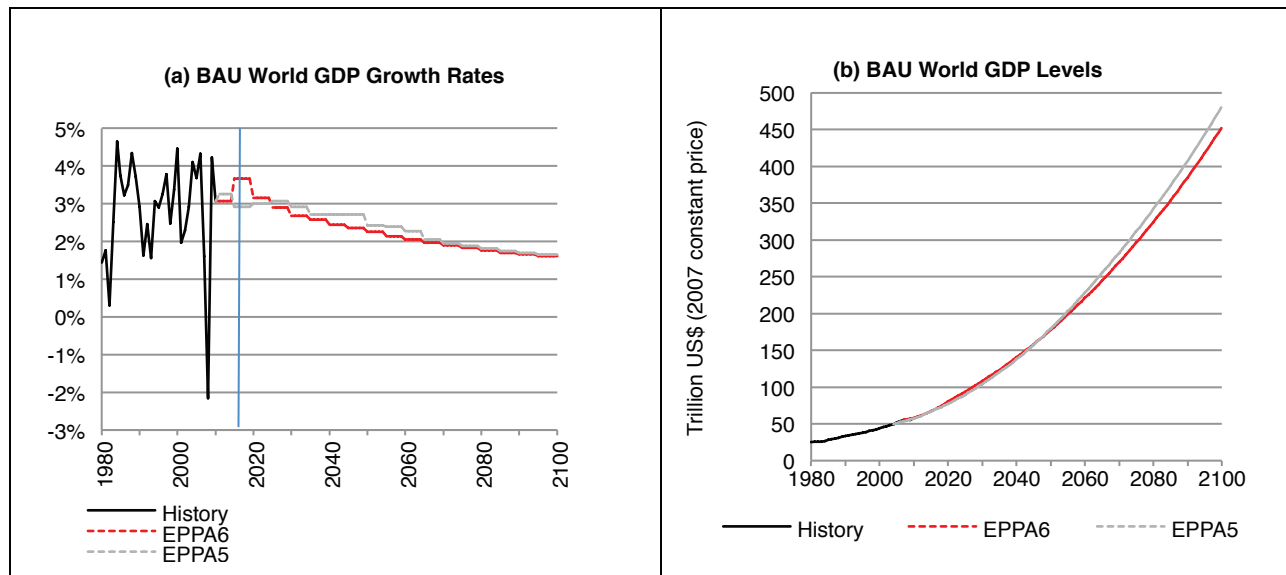
---

<sup>12</sup> We would like to thank Kyung-min Nam and Anna Agarwal for preparing the data.

<sup>13</sup> AEEI does not apply to the refined oil sector, where crude oil is an intermediate input to production.

for 2050 and 2100 are 1.2% and 5.9% lower than those of EPPA5, respectively, as shown in **Figure 5b**. These differences in the overall *level* of GDP, especially in the distant future, mean that the decades-long global growth rates are little changed, with more of the differences reflected in the regions.

Note that the BAU GDP growth of EPPA6-L is calibrated to the scenario where in USA and EUR, expansions of coal-fired power are limited and as a result, coal-fired power outputs will not exceed their 2010 levels. This is different from EPPA5, where the BAU GDP growth is mapped to an unlimited coal-fired power expansion for all regions. The treatment for coal-fired power in EPPA6-L is in line with the BAU projections of IEA (2012) and EIA (2013b), and we believe it better represents the reality in these regions that in part reflects environmental regulations.



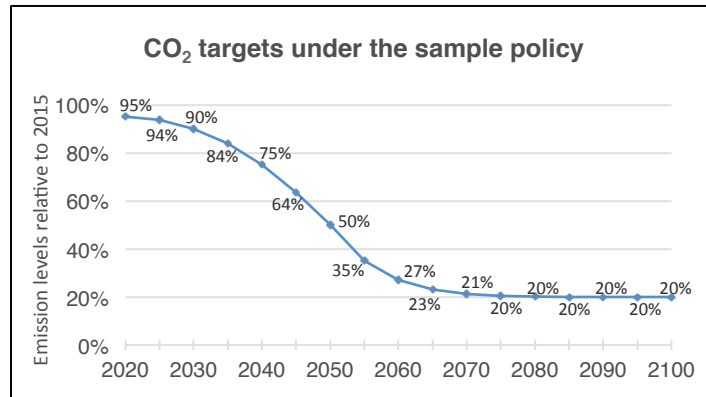
**Figure 5.** BAU world GDP growth projection.

## 5.2 GDP, Energy Use, and Emissions

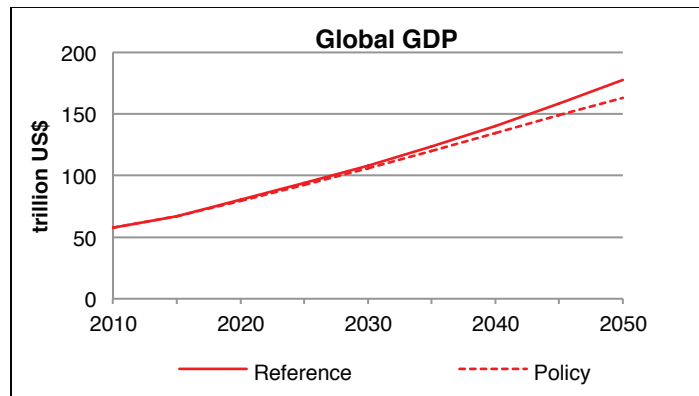
To assess the policy response of EPPA6, we consider a sample greenhouse gas mitigation policy through the 2050 horizon, that continued would keep the world within a two-degree warming target. The IPCC has set forth a carbon budget that approximates, on a century time scale, allowable cumulative emissions that, at median climate response, is associated with 2° C warming (IPCC, 2014a). A path through 2100 consistent with that budget is shown in **Figure 6**.

We implement this path through 2050 in EPPA6-L. To do so, we impose identical percentage reduction caps (from 2015 emissions levels) in each region. The sample policy starts from 2020, cutting CO<sub>2</sub> emissions to 50% of 2015 level by 2050. Other non-CO<sub>2</sub> GHGs are taxed at the same GWP-equivalent (IPCC, 2014b), endogenously determined, regional carbon prices resulting from these caps. The sample policy imposed here is not meant to reflect political feasibility, and as formulated is not necessarily a least-cost policy as the GHG prices vary among regions and are not necessarily inter-temporally optimized. It simply allows us to examine the model performance under an ambitious GHG target that is the stated goal of international

negotiations. The simulation results on global GDP are presented in **Figure 7**, which shows that the sample policy would induce a reduction in global GDP by 2050 of about \$14.5 billion (from about \$177.8 to \$163.1 billion). The cost over the considered time horizon is a reduction of 3.0% in net present value terms compared to BAU, assuming a 5% discount rate. A caveat for the exercise is that simulations for policy impact, by nature, may vary due to factors such as the uncertainties in BAU long-term productivity growth (which in turns affects the economic growth), technology advancement, etc.



**Figure 6.** CO<sub>2</sub> targets under the sample policy.



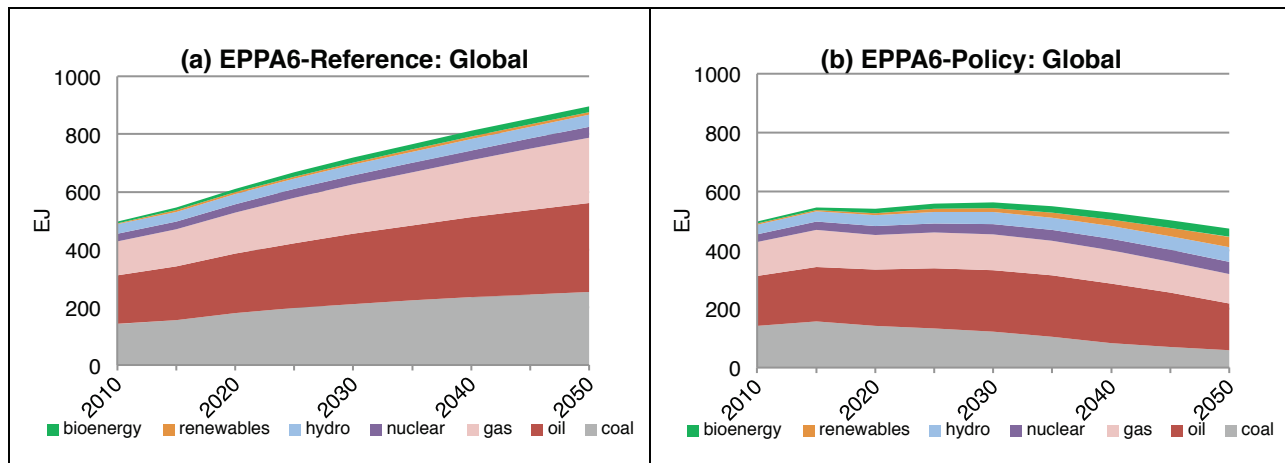
**Figure 7.** Global GDP: BAU vs. Policy.

Since energy use patterns are closely related to emissions, we present model outputs for total primary energy demand (TPED) levels in **Figure 8a** (for the BAU case) and **Figure 8b** (for the policy case). For the BAU simulation, compared to the 2010 level, the global GDP level is tripled (from around \$57.6 trillion to \$177.8 trillion in 2007 US dollars) by 2050. The global TPED increases at a much slower pace by 80.1% (from 497.7 EJ in 2010 to 896.1 EJ in 2050) due to energy efficiency improvements and changes in industrial structure. Nevertheless, the projection shows that the global economy during the same period will continue to rely heavily on fossil fuels with an increasing share of gas (23.6% to 25.4%), while the shares of coal (28.7% to 28.3%) and oil (33.8% to 34.2%) remain almost unchanged. Under this scenario, the roles of hydro, biofuels, other renewables (wind and solar), and nuclear power do not change much over time.

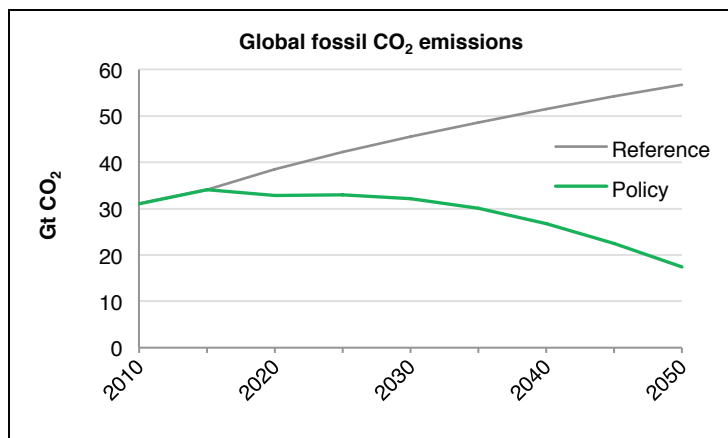


With the sample policy, results shown in Figure 8b suggest that a large cut in fossil fuels consumption is needed to achieve the policy goal (from 428.3 EJ in 2010 to 317.7 EJ in 2050). Under this scenario, as expected, the roles of hydro, biofuels, and other renewables become more important, with the sum of shares rising from about 8.7% in 2010 to 24.0% in 2050. Additionally, the share of nuclear power also increases, from around 5.2% in 2010 to 9.0% in 2050.

**Figure 9** presents the energy-related CO<sub>2</sub> emissions. In the BAU scenario, compared to the 2010 levels, the emissions increase by 82.7% by 2050, which are directly related to the consumption of fossil fuels that increases by 84.0% during the same period. The slightly slower growth path of the emissions is a result of the slight increase in the share of gas, as discussed previously. With the sample policy, the emission level will be cut by almost 70% relative to the reference level in 2050.



**Figure 8.** Total primary energy demand: BAU vs. Policy.



**Figure 9.** Global fossil CO<sub>2</sub> emissions.

### 5.3 Final Consumption for Food and Agricultural Products

Consumptions for food and agricultural products are closely related to production activities of agricultural sectors (CROP and LIVE), which may induce land-use changes and result in GHG implications. To improve our projections, we incorporate the income elasticity estimates for the final consumption of CROP, LIVE, and FOOD from Reimer and Hertel (2004). As mentioned in Section 4, the estimates have been adjusted to reflect the economic environment of our base year.

It is worth noting that, as illustrated in Section 2, since the labor endowment (and population) of the representative consumer increases over time, the representative consumer of the model is indeed an aggregated consumer, which means that, on top of the income elasticity estimates for an individual  $\eta_i$  presented in Equation (5), income elasticities for the model's representative consumer, denoted by  $\eta'_i$ , should take into account the population growth. Taking total derivatives on aggregate consumption and budget to decompose changes and rearranging terms, we have:

$$\eta'_i = \frac{\eta_i \frac{dw}{w} + \frac{dpop}{pop}}{\frac{dw}{w} + \frac{dpop}{pop}} \quad (13)$$

In Equation (13),  $w$  is the budget (see Section 2) and  $pop$  is the population index of each region with the base year level normalized to unity (the regional index is dropped for succinctness). Besides using Reimer and Hertel's income elasticity estimates, for comparison purposes, we also present results based on estimates from USDA (2013), and those with a pure CES setting. **Table 8** presents the income elasticity estimates of USDA, which are based on the International Comparison Program (ICP) data across 144 countries.<sup>14</sup>

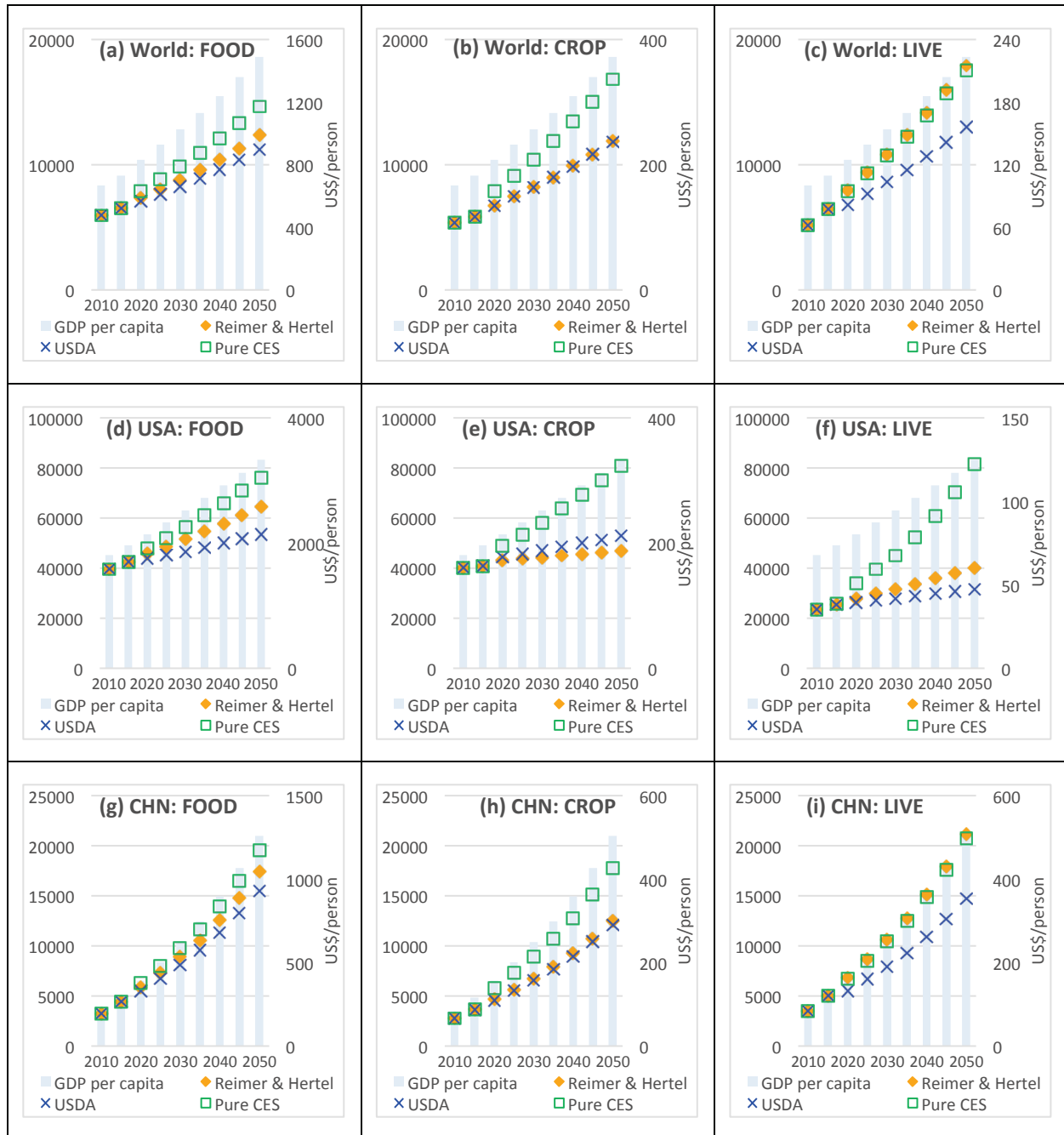
**Figure 10** demonstrates the BAU projections for final consumption per capita as GDP per capita grows over time, starting from 2010 up to 2050. The results show that, with income elasticity adjustments, global food and crop consumption projections are lowered compared to those with a pure CES setting, which most likely overestimates the consumption levels as it fails to take into account the empirical evidence that income elasticities for food consumption are

**Table 8.** Income elasticity for agricultural and food products from USDA.

	CROP	LIVE	FOOD		CROP	LIVE	FOOD
USA	0.210	0.260	0.346	CHN	0.617	0.654	0.775
CAN	0.315	0.369	0.477	IND	0.621	0.660	0.782
MEX	0.440	0.506	0.646	BRA	0.517	0.571	0.704
JPN	0.324	0.380	0.492	AFR	0.561	0.622	0.752
ANZ	0.380	0.452	0.588	MES	0.456	0.534	0.666
EUR	0.283	0.385	0.503	LAM	0.501	0.562	0.699
ROE	0.488	0.563	0.697	REA	0.601	0.644	0.772
RUS	0.443	0.532	0.672	KOR	0.428	0.479	0.600
ASI	0.461	0.514	0.641	IDZ	0.572	0.621	0.757

Source: USDA (2013)

<sup>14</sup> We approximate the elasticity levels of 2007 for our model by the USDA data, which are for the year 2005.



**Figure 10.** Final consumption projections for food, crop, and livestock products.

generally less than one. Using Reimer and Hertel’s estimates, global food consumption projection in 2050 is 15.9% lower compared to the case with a pure CES setting. Furthermore, the projection will be more than 23.6% lower if the USDA data were used, as shown in **Figure 10a**. Note that except for the income elasticity of crop consumption, USDA data in general have lower income elasticity numbers compared to those of Reimer and Hertel (as seen in a comparison between Tables 6 and 8). On the other hand, for global crop consumption (**Figure 10b**), using the Reimer and Hertel estimates and those of USDA produce similar

projections, which are around 30% lower than the pure CES projection in 2050. This comes from the fact that both studies have quite similar estimates for the income elasticities of crop consumption. Lastly, as **Figure 10c** shows, the projections for global livestock consumption based on Reimer and Hertel's estimates are very close to those with a pure CES setting, as Reimer and Hertel's income elasticity estimates for livestock products are generally higher (see Table 6 in Section 4). Using USDA's income elasticity estimates again produce lower projections (26.1% lower in 2050 compared to the other two cases). Projections at the regional levels are presented for USA and CHN, as shown in **Figure 10d** through **Figure 10i**. In short, comparisons can reveal that 1) income elasticity adjustments tend to lower projections for food, crop, and livestock consumption levels; 2) the USA has lower growth rates for the consumption levels of these products compared to those of CHN, since the USA has lower income elasticity estimates; and 3) except for crop consumption in the USA, projections based on USDA estimates are lower as the underlying elasticity numbers of USDA are lower.

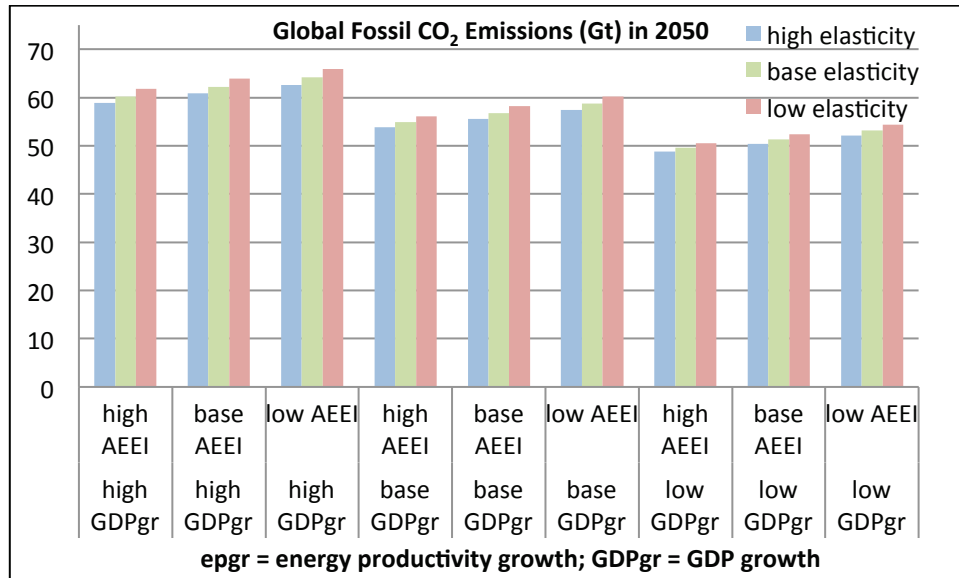
#### 5.4 Sensitivity Analyses

Long-term projections for future emissions and CO<sub>2</sub> prices are closely related to energy use levels, which are in turn determined by many other parameters with values that may be subject to uncertainty. For instance, Paltsev *et al.* (2005) and Webster *et al.* (2003) point out that economic growth is one of the most important drivers for energy use and emissions, and Webster *et al.* (2008) finds that the main sources of uncertainty in CO<sub>2</sub> prices come from energy demand parameters, including substitution elasticities between energy and non-energy (capital and labor) inputs and AEEI. While an extensive uncertainty analysis is beyond the scope of this paper, to explore the performance of EPPA6-L, we present the sensitivity analysis with various assumptions in: 1) BAU GDP growth; 2) AEEI; and 3) elasticities of substitution between energy and non-energy inputs.

For all three types of parameters, we consider a 20% range of deviation from the values used in EPPA6-L. In **Figure 11**, we use “base” to denote the adoption of parameter values with the original EPPA6-L numbers, “high” means the considered parameter value is 20% higher than the base level, and “low” can be interpreted following the same logic.<sup>15</sup> As Figure 11 shows, the projected BAU global CO<sub>2</sub> emissions in 2050 are most sensitive to GDP growth assumptions. For instance, holding the other two parameter values at their base levels, if we normalize the global emissions to one, the range of emissions due to different GDP growth levels is between 0.90 and 1.09, and ranges of emissions due to various energy productivity growth levels and elasticity assumptions are in the 0.97–1.03 and 0.98–1.02 ranges, respectively. Emissions are less sensitive to the assumption for energy productivity growth due to the “rebound effect” of efficiency improvement. More specifically, the non-price driven efficiency improvement lowers demand for

---

<sup>15</sup> For instance, a “high” GDP growth represents the annual GDP growth rate is 20% higher, a “low” AEEI means the annual autonomous efficiency improvement rate is 20% lower, etc., compared to numbers with the “base” scenario (the original setting).



**Figure 11.** BAU global combusted CO<sub>2</sub> emissions under different assumptions.

energy and thus the energy price, but the cheaper price encourages energy use and so the overall energy saving and reduced emissions are not as high as one might expect. Applying the same rationale in the reverse direction explains the result for a decrease in energy productivity growth. On the other hand, the substitution elasticity between the energy and non-energy input can capture the price driven efficiency improvement. For instance, to produce the same output, with a higher elasticity level, it will be easier to use more capital, labor, and other intermediate inputs to replace the energy input when the relative price of energy increases. We find that, at the global level, emissions are least sensitive to changes in substitution elasticities. The caution here is that the importance of the substitution elasticity also interacts with the projected price path of energy. If the relative prices of energy were projected to be stable over time, then the elasticity would have little or no effect. Another caveat is that the 20% deviations are arbitrary. If, for example, we were far more certain about energy productivity growth or GDP growth than about elasticities, then the uncertainty in elasticities could cause larger variation in outcomes even though the sensitivity to a fixed range is less. Nevertheless, these sensitivity analyses are informative to study the model response.

**Figure 12** presents BAU CO<sub>2</sub> emissions and CO<sub>2</sub> prices under the sample policy for selected regions. We find that up to 2050, deviations of emissions projections from the base case (the original setting of EPPA6) are mostly less than 10% under the considered sensitivity analysis. The only exception is the case of CHN under the highest GDP growth assumptions, which result in slightly higher deviations from the base case (in the range of 0.90–1.10 if we normalize the base case emissions level in 2050 to one). Not surprisingly the range outcomes grows the further in the future the projection. As is the case for the world as whole, different energy productivity growth and elasticity levels have smaller effects on BAU emissions. Also, compared to the cases of other regions, changes in China’s BAU GDP growth have higher impacts on its emissions since the base case GDP growth levels of CHN are the highest among all of the modeled regions.

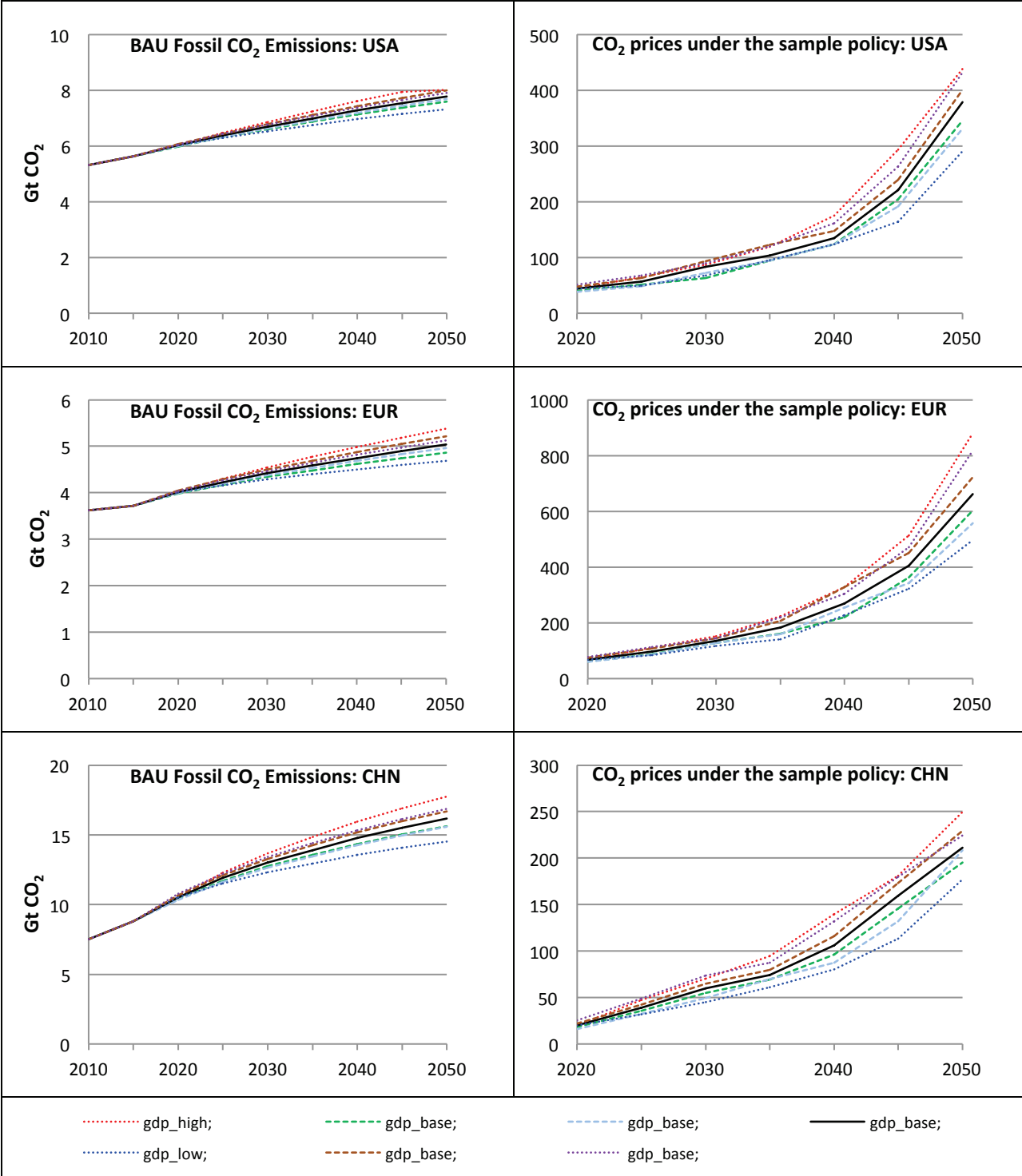


Figure 12. BAU combusted CO<sub>2</sub> emissions and CO<sub>2</sub> prices under the sample policy.

Figure 12 also presents the projected CO<sub>2</sub> prices for selected regions under the sample policy. The higher CO<sub>2</sub> prices of EUR reflect the fact that EUR is less coal-intensive and thus less carbon-intensive from the beginning, and therefore has fewer options to decarbonize. In the US and China a simple shift to natural gas can achieve significant reductions in emissions from electricity generation. If we use the emissions to GDP ratio as the proxy for the average carbon intensity level of economic activities, the base year number of EUR is 0.21Kg/US\$, which is much lower than those for USA (0.41 Kg/US\$) and CHN (1.69 Kg/US\$). Similarly, we also observe that CHN, which is the most carbon intensive among the three regions from the beginning, has the lowest projected CO<sub>2</sub> prices over time.

The projected CO<sub>2</sub> prices may also change due to uncertainties in those considered parameters. As expected, for each region, different GDP growth assumptions contribute to a higher variation in CO<sub>2</sub> prices, as uncertainty in economic growth accounts for more variations in emissions. Uncertainties in energy productivity growth and substitution elasticities also affect CO<sub>2</sub> price projections. Higher energy productivity growth levels reduce fossil fuels consumption and emissions, and therefore lower CO<sub>2</sub> prices. On the other hand, higher elasticity levels makes it easier to switch from burning fossil fuels (which incurs carbon penalties) to using other non-energy inputs, and lower elasticity levels make the switch for avoiding the carbon penalty trickier. The finding suggests that in addition to uncertainty in future economic growth, careful research to characterize energy productivity growth and the ability of energy and non-energy substitution is crucial in reducing the uncertainty in CO<sub>2</sub> price projections.

## 6. CONCLUSIONS

Large scale energy-economic CGE models have been used extensively for various policy analyses. In addition, they are often crucial components of various integrated assessment frameworks, which are used for studying interdisciplinary questions within broader contexts. However, in many cases, perhaps due to the lack of transparency, explaining and comparing model results could be challenging even for researchers. This study aims to bridge this gap by providing details for the data, structure, features, and improvements of EPPA6-L. We believe future studies with comparable efforts for other models will be valuable as well.

Any long-term projection from an energy-economic model will inevitably involve distinct aspects of uncertainty, including factors including (but not limited to) economic growth, autonomous energy efficiency improvement, and substitution elasticity between energy and non-energy inputs. As a result, in this study, we pick up these three parameters to demonstrate how changes in their values may affect CO<sub>2</sub> emissions levels and prices. We also explore the implications of adopting non-homothetic preferences on the projections for food and agricultural products' consumption, which are also crucial as numerous studies have found the evidence against the assumption of an income elasticity of one for the consumption of these products.

Based on EPPA6-L, the developments of several EPPA6 versions are underway, including:

- 1) *EPPA6 with a comprehensive representation for land-use change*: following the framework developed by Gurgel *et al.* (2007), economic incentives for land-use conversions as well as CO<sub>2</sub>

emissions from the land-use changes will be considered; 2) *EPPA6 with details for first generation biofuels*: as presented by Gitiaux *et al.* (2012), different biofuels production activities will be identified, each with its own land-use and carbon footprint implications; 3) *EPPA6 with refined oil sectors details*: as in Choumert *et al.* (2006), the single refined oil product of GTAP 8 will be disaggregated into different petroleum products with various uses and emissions factors; and 4) *EPPA6 with household transportation details*: based on Karplus *et al.* (2013b), household owned-supplied transportation (service from private automobiles) will be disaggregated by age and powertrains to improve policy analyses such as fuel efficiency requirements on automobiles.

## Acknowledgments

We gratefully acknowledge the financial support for this work provided by the MIT Joint Program on the Science and Policy of Global Change through a consortium of industrial and foundation sponsors and Federal awards, including the U.S. Department of Energy, Office of Science under DE-FG02-94ER61937 and the U.S. Environmental Protection Agency under XA-83600001-1. For a complete list of sponsors and the U.S. government funding sources, please visit <http://globalchange.mit.edu/sponsors/all>. We are also thankful for comments from participants of the 17<sup>th</sup> GTAP Conference and the MIT EPPA meeting, and feedback from Jamie Bartholomay, Paul Kishimoto, and Giacomo Schwarz. All remaining errors are our own.

## 7. REFERENCES

- Armington, P.S., 1969: A Theory of Demand for Products Distinguished by Place of Production. *International Monetary Fund Staff Papers* **16**: 159–176.
- Babiker, M.H., J.M. Reilly, M. Mayer, R.S. Eckaus, I. Sue Wing and R.C. Hyman, 2001: The MIT Emissions Prediction and Policy Analysis (EPPA) Model: Revisions, Sensitivities, and Comparisons of Results. MIT JPSPGC *Report 71*, Cambridge, MA ([http://globalchange.mit.edu/files/document/MITJPSPGC\\_Rpt71.pdf](http://globalchange.mit.edu/files/document/MITJPSPGC_Rpt71.pdf)).
- Bechtel Power Corporation, 1981: Coal-fired Power Plants Capital Cost Estimates. Report prepared for the Electric Power Research Institute. San Francisco, CA 94119.
- Boden, T.A., G. Marland, and R.J. Andres, 2010: Global, Regional, and National Fossil-Fuel CO<sub>2</sub> Emissions. Carbon Dioxide Information Analysis Center, Oak Ridge National Laboratory, U.S. Department of Energy, Oak Ridge, Tenn., USA.
- Choumert, F., S. Paltsev and J. Reilly, 2006: Improving the Refining Sector in EPPA. MIT JPSPGC *Technical Note 9*, July, 56 p. ([http://globalchange.mit.edu/files/document/MITJPSPGC\\_TechNote9.pdf](http://globalchange.mit.edu/files/document/MITJPSPGC_TechNote9.pdf)).
- Cossa, P., 2004: *Uncertainty Analysis of the Cost of Climate Policies*. Master of Science Thesis, Technology and Policy Program, MIT, Cambridge, Massachusetts.
- Empresa de Pesquisa Energética (EPE), 2007: *Plano Nacional de Energia 2030*. Empresa de Pesquisa Energética, Brasilia, Brazil ([http://www.epe.gov.br/PNE/20080512\\_2.pdf](http://www.epe.gov.br/PNE/20080512_2.pdf)).
- Energy Information Administration (EIA), 2013a: *How Old Are U.S. Power Plants?* U.S. Energy Information Administration, Washington, D.C. ([http://www.eia.gov/energy\\_in\\_brief/article/age\\_of\\_elec\\_gen.cfm](http://www.eia.gov/energy_in_brief/article/age_of_elec_gen.cfm)).



- Energy Information Administration (EIA), 2011: Age of electric power generators varies widely. *Today in Energy*. U.S. Energy Information Administration, Washington, D.C. (<http://www.eia.gov/todayinenergy/detail.cfm?id=1830>).
- Energy Information Administration (EIA), 2013b: *Annual Energy Outlook 2013: With Projections to 2040*. U.S. Energy Information Administration, Washington, D.C. ([http://www.eia.gov/forecasts/aeo/MT\\_electric.cfm](http://www.eia.gov/forecasts/aeo/MT_electric.cfm)).
- Energy Information Administration (EIA), 2010: *Annual Energy Outlook 2010: With Projections to 2035*. U.S. Energy Information Administration, Washington, D.C. (<http://www.eia.gov/oiaf/aeo/pdf/0383%282010%29.pdf>).
- European Commission (EC), 2011: Emission Database for Global Atmospheric Research (EDGAR), release version 4.2. Joint Research Centre (JRC)/Netherlands Environmental Assessment Agency (PBL), EC (<http://edgar.jrc.ec.europa.eu>).
- Ferris, M. C. and J. S. Pang, 1997: Engineering and Economic Applications of Complementarity Problems. *SIAM Review*, **39**(4): 669-713.
- Gitiaux, X., S. Paltsev, J. Reilly and S. Rausch, 2012: Biofuels, Climate Policy, and the European Vehicle Fleet. *Journal of Transport Economics and Policy* **46**(1): 1–23.
- Global Trade Analysis Project (GTAP), 2013: *GTAP Databases: GTAP 8 Database*. Center for Global Trade Analysis, Department of Agricultural Economics, Purdue University, March. (<https://www.gtap.agecon.purdue.edu/databases/v8/>).
- Gordon, R. J., 2012: Is U.S. Economic Growth Over? Faltering Innovation Confronts the Six Headwinds, National Bureau of Economic Research *Working Paper 18315*, Cambridge, MA (<http://www.nber.org/papers/w18315>).
- Gurgel, A., J. Reilly, and S. Paltsev, 2007: Potential Land Use Implications of a Global Biofuels Industry. *Journal of Agricultural & Food Industrial Organization* **5**(2): Article 9.
- Haque, M.O., 2005: *Income Elasticity and Economic Development: Methods and Applications*. 277 p., Springer.
- International Energy Agency (IEA), 2012: *World Energy Outlook*. International Energy Agency, Paris, France (<http://www.worldenergyoutlook.org/publications/weo-2012/>).
- International Monetary Fund (IMF), 2013: *World Economic and Financial Surveys: World Economic Outlook Database*, Washington, D.C., USA (<http://www.imf.org/external/pubs/ft/weo/2013/01/weodata/download.aspx>).
- Intergovernmental Panel on Climate Change (IPCC), 2014a: *Climate Change 2014 Synthesis Report: Summary for Policymakers*. IPCC Secretariat, World Meteorological Organization, Geneva, Switzerland.
- Intergovernmental Panel on Climate Change (IPCC), 2014b: *Fifth Assessment Report*. IPCC Secretariat, World Meteorological Organization, Geneva, Switzerland.
- Jacoby, H. D. and Y.-H.H. Chen, 2014: Expectations for a New Climate Agreement. MIT JPSPGC *Report 264*, August, 24 p. ([http://globalchange.mit.edu/files/document/MITJPSPGC\\_Rpt264.pdf](http://globalchange.mit.edu/files/document/MITJPSPGC_Rpt264.pdf)).
- Jacoby, H. D., F. M. O’Sullivan, and S. Paltsev, 2012: The Influence of Shale Gas on U.S. Energy and Environmental Policy. *Economics of Energy & Environmental Policy* **1**(1): 37–51.

- Karplus, V.J., S. Paltsev, M. Babiker and J.M. Reilly, 2013a: Should a vehicle fuel economy standard be combined with an economy-wide greenhouse gas emissions constraint? Implications for energy and climate policy in the United States. *Energy Economics* **36**: 322–333.
- Karplus, V.J., S. Paltsev, M. Babiker and J.M. Reilly, 2013b: Applying engineering and fleet detail to represent passenger vehicle transport in a computable general equilibrium model. *Economic Modelling* **30**: 295–305.
- Markusen, J. and T. F. Rutherford, 2004: Getting Started with GAMS/MCP: Introduction to Computable General Equilibrium Modeling with GAMS and MPSGE. University of Colorado, Boulder (<http://www.mpsge.org/gettingstarted.pdf>).
- Markusen, J., 2006: Extension of the Simple Model. University of Colorado, Boulder ([http://spot.colorado.edu/~markusen/teaching\\_files/applied\\_general\\_equilibrium/GAMS/ch2.pdf](http://spot.colorado.edu/~markusen/teaching_files/applied_general_equilibrium/GAMS/ch2.pdf)).
- Markusen, J., 2013: General-Equilibrium Modeling using GAMS and MPS/GE: Some Basics. University of Colorado, Boulder ([http://spot.colorado.edu/~markusen/teaching\\_files/applied\\_general\\_equilibrium/GAMS/ch1.pdf](http://spot.colorado.edu/~markusen/teaching_files/applied_general_equilibrium/GAMS/ch1.pdf)).
- Mathiesen, L., 1985: Computation of Economic Equilibra by a Sequence of Linear Complementarity Problems. *Mathematical Programming Study* **23**: 144-162.
- McCarl, B., A. Meeraus, P. van der Eijk, M. Bussieck, S. Dirkse, P. Steacy, and F. Nelissen, 2014: *McCarl Expanded GAMS User Guide: Version 24.3* ([http://www.gams.com/mccarl/mccarlhtml/gams\\_user\\_guide\\_2005.htm](http://www.gams.com/mccarl/mccarlhtml/gams_user_guide_2005.htm)).
- MIT Joint Program, 2013: *2013 Energy and Climate Outlook*, MIT Joint Program on the Science and Policy of Global Change, Cambridge, MA.
- Morris, J., J. Reilly, and Y.-H. H. Chen, 2014: Advanced Technologies in Energy-Economy Models for Climate Change Assessment. MIT JPSPGC forthcoming report, 29 p.
- Nam, K.-M., C.J. Waugh, S. Paltsev, J.M. Reilly and V.J. Karplus, 2013: Carbon co-benefits of tighter SO<sub>2</sub> and NO<sub>x</sub> regulations in China. *Global Environmental Change* **23**(6): 1648–1661, 2013.
- Narayanan, G., Badri, T. W. Hertel and T. L. Walmsley, 2012: GTAP 8 Data Base Documentation – Chapter 1: Introduction. Center for Global Trade Analysis, Department of Agricultural Economics, Purdue University, March (<https://www.gtap.agecon.purdue.edu/resources/download/5673.pdf>).
- Paltsev, S., V. Karplus, Y.-H.H. Chen, I. Karkatsouli, J.M. Reilly and H.D. Jacoby, 2014a: Regulatory Control of Vehicle and Power Plant Emissions: How Effective and at What Cost? *Climate Policy*, forthcoming.
- Paltsev S., Y.-H.H. Chen, J. Reilly, J. Morris, V. Karplus, A. Gurgel, N. Winchester, P. Kishimoto, E. Blanc, and Q. Ejaz, 2014b: The MIT Emissions Prediction and Policy Analysis (EPPA) Model: Version 5. MIT JPSPGC forthcoming report.
- Paltsev, S., H.D. Jacoby, J.M. Reilly, Q.J. Ejaz, J. Morris, F. O'Sullivan, S. Rausch, N. Winchester and O. Kragha, 2011: The Future of U.S. Natural Gas Production, Use, and Trade. *Energy Policy* **39**(9): 5309–5321.
- Paltsev S., J. Reilly, H. Jacoby, R. Eckaus and J. McFarland and M. Babiker, 2005: The MIT Emissions Prediction and Policy Analysis (EPPA) Model: Version 4. MIT JPSPGC *Report 125*, August, 72 p. ([http://globalchange.mit.edu/files/document/MITJPSPGC\\_Rpt125.pdf](http://globalchange.mit.edu/files/document/MITJPSPGC_Rpt125.pdf)).

- Riahi, K., A. Gruebler, and N. Nakicenovic, 2007: Scenarios of long-term socio-economic and environmental development under climate stabilization. *Technological Forecasting and Social Change* **74**(7), 887–935.
- Reimer, J. and T. W. Hertel, 2004: Estimation of International Demand Behavior for Use with Input-Output Based Data. *Economic Systems Research* **16**(4): 347–366.
- Rutherford, T. 1995: Extension of GAMS for Complementarity Problems Arising in Applied Economic Analysis. *Journal of Economic Dynamics and Control* **19**: 1299-1324.
- Rutherford, T. 1999: Applied General Equilibrium Modeling with MPSGE as a GAMS Subsystem: An Overview of the Modeling Framework and Syntax. *Computational Economics* **14**: 1–46.
- [USDA] United States Department of Agriculture, 2013: International Food Consumption Patterns. Washington, D.C. (<http://www.ers.usda.gov/data-products/international-food-consumption-patterns.aspx#26207>).
- United Nations, 2013: World Population Prospects: The 2012 Revision. Population Division, United Nations, New York, USA (<http://esa.un.org/unpd/wpp/Excel-Data/population.htm>).
- Webster, M, S. Paltsev, J. Parsons, J. Reilly, and H. Jacoby, 2008: Uncertainty in Greenhouse Gas Emissions and Costs of Atmospheric Stabilization. MIT JPSPGC *Report 165*, November, 81 p. ([http://globalchange.mit.edu/files/document/MITJPSPGC\\_Rpt165.pdf](http://globalchange.mit.edu/files/document/MITJPSPGC_Rpt165.pdf)).
- Webster, M., C. Forest, J. Reilly, M. Babiker, D. Kicklighter, M. Mayer, R. Prinn, M. Sarofim, A. Sokolov, P. Stone, and C. Wang, 2003: Uncertainty Analysis of Climate Change and Policy Response. *Climate Change* **61**: 295–320.
- Webster, M., M. Babiker, M. Mayer, J.M. Reilly, J. Harnisch, R. Hyman, M.C. Sarofim, C. Wang, 2002: Uncertainty in emissions projections for climate models. *Atmospheric Environment* **36**: 3659–3670.
- Winchester, N., D. McConnachie, C. Wollersheim and I.A. Waitz, 2013: Economic and emissions impacts of renewable fuel goals for aviation in the US. *Transportation Research Part A: Policy and Practice* **58**(2013): 116–128.
- The World Bank, 2013: *China 2030: Building a Modern, Harmonious, and Creative Society*. Washington, D.C. (<http://documents.worldbank.org/curated/en/2013/03/17494829/china-2030-building-modern-harmonious-creative-society>).
- Zhou, Z., W. Tian, J. Wang, H. Liu, and L. Cao, 2012: Food Consumption Trends in China. Report submitted to the Australian Government Department of Agriculture, Fisheries and Forestry ([http://www.daff.gov.au/\\_data/assets/pdf\\_file/0006/2259123/food-consumption-trends-in-china-v2.pdf](http://www.daff.gov.au/_data/assets/pdf_file/0006/2259123/food-consumption-trends-in-china-v2.pdf)).

**APPENDIX A: DERIVING THE SUBSISTENCE CONSUMPTION LEVELS  
FOR THE STONE-GEARY SYSTEM**

*Problem:*

Show that Equation (6) is the solution to Equation (5), i.e., given the budget constraint  $\sum_{i=1}^N c_i = w$ , for any  $i = 1, 2, \dots, N$ ,  $c_i^* = (1 - \eta_i)c_i$  is the solution for a given vector of  $\eta_i$ .

*Answer:*

Step 1:

Following the definition for  $\eta_i$ , we have:

$$\frac{\eta_i}{\eta_j} = \frac{\left(\frac{c_i - c_i^*}{c_i}\right) / \left(\frac{w - \sum_{i=1}^N c_i^*}{w}\right)}{\left(\frac{c_j - c_j^*}{c_j}\right) / \left(\frac{w - \sum_{j=1}^N c_j^*}{w}\right)} = \frac{\left(\frac{c_i - c_i^*}{c_i}\right)}{\left(\frac{c_j - c_j^*}{c_j}\right)} \quad (\text{A1})$$

Rearrange terms, we can get:

$$\frac{c_j - c_j^*}{c_i - c_i^*} = \frac{\eta_j c_j}{\eta_i c_i} \quad (\text{A2})$$

Step 2:

Equation (A2) suggests that the candidate for the solution can be  $c_i^* = (1 - \eta_i)c_i$ . We need to verify this is indeed the case, i.e., we need to show that  $c_i^* = (1 - \eta_i)c_i$  satisfies Equations (A1) and (A2). It is straightforward to show that Equation (A2) is satisfied. Let us plug  $c_i^* = (1 - \eta_i)c_i$  into the right hand side of Equation (A1):

$$\frac{c_i - c_i^*}{c_i} = \frac{c_i - (1 - \eta_i)c_i}{c_i} = \eta_i \quad (\text{A3})$$

Since from the budget constraint we have  $\sum_{i=1}^N c_i = w$ , and  $\sum_{i=1}^N \frac{c_i}{w} \eta_i = 1$  is just the Engel's Aggregation, thus:

$$\frac{w - \sum_{i=1}^N c_i^*}{w} = \frac{w - \sum_{i=1}^N (1 - \eta_i)c_i}{w} = \frac{w - \sum_{i=1}^N c_i + \sum_{i=1}^N \eta_i c_i}{w} = \sum_{i=1}^N \frac{c_i}{w} \eta_i = 1 \quad (\text{A4})$$

As a result, the numerator of the right hand side of Equation (A1) is equal to  $\eta_i$ . Similarly, the denominator of Equation (A1)'s right hand side is  $\eta_j$ . Therefore  $c_i^* = (1 - \eta_i)c_i$  is the solution to the problem.

## APPENDIX B: RECALIBRATING THE SUBSISTENCE CONSUMPTION IN LATER PERIODS

We demonstrate in Appendix A how to derive the base year subsistence consumption level to match a given income elasticity. Now, we will show for later years, how to recalculate the subsistence consumption  $c$  of a commodity  $x$  to approximate the underlying income elasticity (the sectorial index  $i$  is dropped for simplicity). Let us use  $t$  as the notation for the time period ( $t = 0, 1, 2, \dots, N$ ), use  $y$  for the aggregate consumption of commodities other than  $x$ , and use  $w$  for the budget level, as shown in **Figure B1**.

With the base year ( $t = 0$ ) consumption bundle  $A_0: (x_0, y_0)$  and income elasticity  $\eta_x$ , we can derive  $c_0 = (1 - \eta_x)x_0$  based on Appendix A. Now, if both  $\eta_x$  and the relative price between  $x$  and  $y$  were held constant, the consumption bundles of  $t = 1$  and  $t = 2$  become  $A_1^T: (x_1^T, y_1^T)$  and  $A_2^T: (x_2^T, y_2^T)$ , respectively; i.e., the desired income-consumption curve is  $A_0A_1^TA_2^T$ . Our strategy is to approximate  $A_0A_1^TA_2^T$  by  $A_0A_1A_2$ , where  $A_1$  is the consumption bundle with: 1)  $w = w_1$ ; 2) the base year relative price; and 3) the Stone-Geary preference characterized by  $c = c_0$ , and  $A_2$  is the consumption bundle with 1)  $w = w_2$ ; 2) the base year relative price; and 3) the Stone-Geary preference characterized by  $c = c_1$ .

Note that we do not recalculate  $c$  until  $t = 2$ , while information from both  $t = 1$  and  $t = 0$  becomes available and allows us to derive  $c_1$ , the subsistence consumption of  $t = 2$ . The same procedure is applied to derive  $c_2$  for  $t = 3$  (using information from  $t = 2$  and  $t = 0$ ) up to  $c_{N-1}$  for  $t = N$  (using information from  $t = N - 1$  and  $t = 0$ ). Also note that for all periods, the preference is always calibrated at the point  $A_0: (x_0, y_0)$ , although the subsistence consumption  $c$  may vary. To calculate  $c_1$ , the idea is to solve for  $A_1^T: (x_1^T, y_1^T)$ , and then together with the given  $A_0: (x_0, y_0)$ , use the line  $A_0A_1^T$  to find  $c_1$  by setting  $y = 0$ . Similarly,  $c_2$  (used in  $t = 3$ ) can be determined by the intersection of  $A_0A_2^T$  and the  $x$ -axis ( $y = 0$ ), and so on. In the following, we explain the procedure of deriving  $c_1$ .

Step 1:

From  $\eta_x = \frac{x_1^T - x_0}{x_0} / \frac{w_1 - w_0}{w_0}$  and  $x_1^T + y_1^T = w_1$ , we can solve for  $x_1^T$  and  $y_1^T$ :

$$x_1^T = x_0 \left( \eta_x \frac{w_1 - w_0}{w_0} + 1 \right) \tag{B1}$$

$$y_1^T = w_1 - x_1^T \tag{B2}$$

Therefore, we can determine the equation for  $\overleftrightarrow{A_0A_1^T}$ :

$$y - y_1^T = \frac{y_1^T - y_0}{x_1^T - x_0} (x - x_1^T) \tag{B3}$$

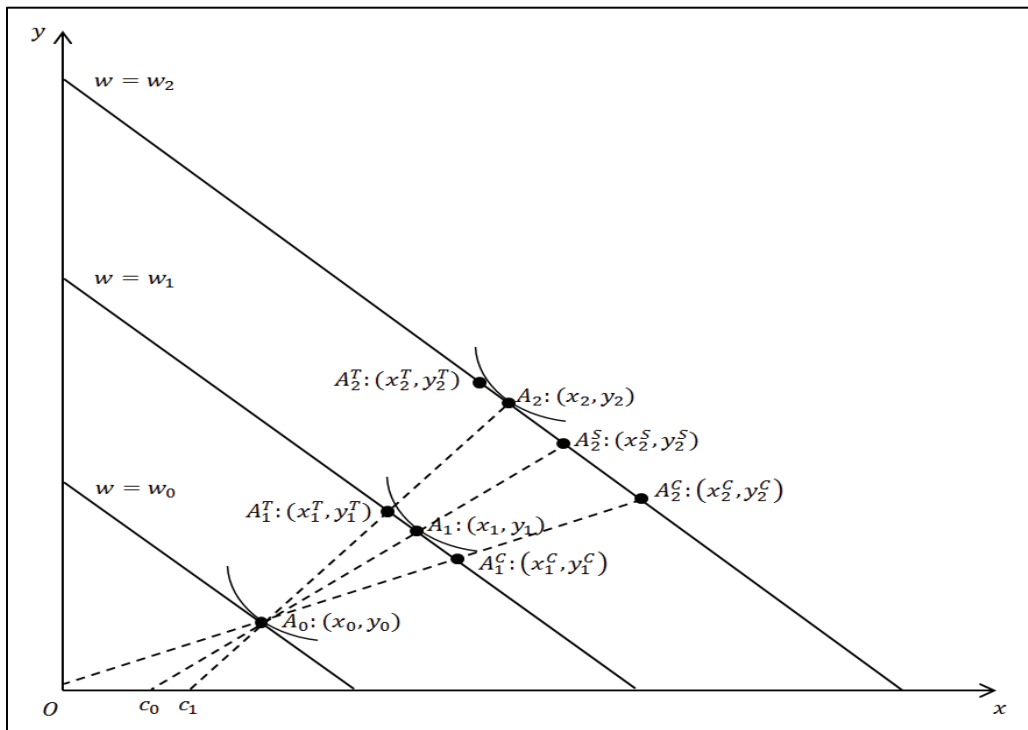
Step 2:

Using  $y = 0$  in Equation (B3), we can solve for  $x$  and get:

$$c_1 = x = x_1^T - y_1^T \cdot \frac{x_1^T - x_0}{y_1^T - y_0} \quad (\text{B4})$$

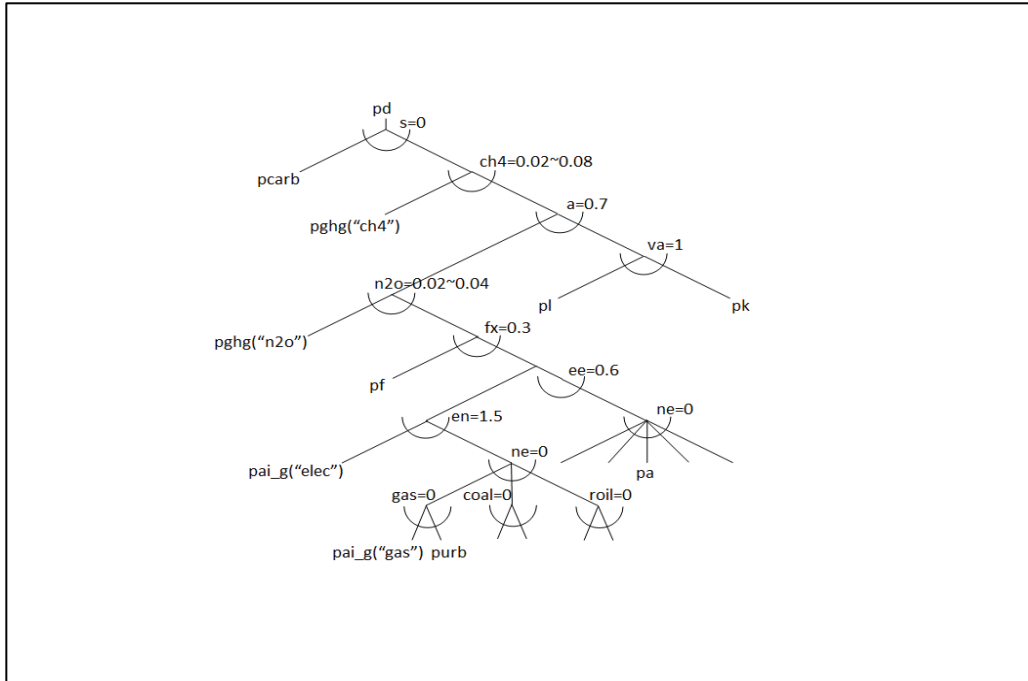
Applying the same procedure, we can also solve for the sequence of subsistence consumption  $(c_2, c_3, \dots, c_{N-1})$  for  $t = 3$  to  $t = N$ .

For comparison purposes, **Figure B1** also shows that, with the pure CES setting, the income-consumption curve is  $A_0A_1^cA_2^c$ , which incurs the largest bias from the desired curve  $A_0A_1^T A_2^T$ . If the subsistence consumption were kept at  $c_0$  for all periods (which is the pure Stone-Geary case), the income-consumption curve  $A_0A_1A_2^s$  gets somewhat closer to  $A_0A_1^T A_2^T$  but the approximation still becomes worse as income grows. Compared to the pure CES or Stone-Geary settings, our approach that generates the income-consumption curve  $A_0A_1A_2$  provides a much better approximation to the desired income-consumption curve.

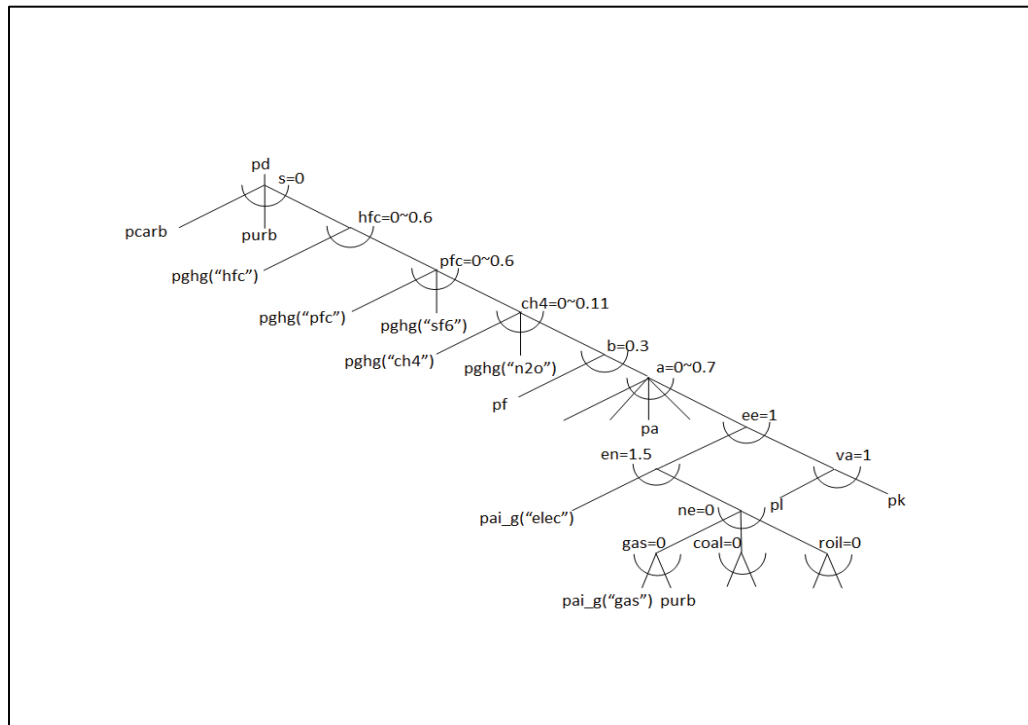


**Figure B1.** Consumption bundles with various income elasticities.

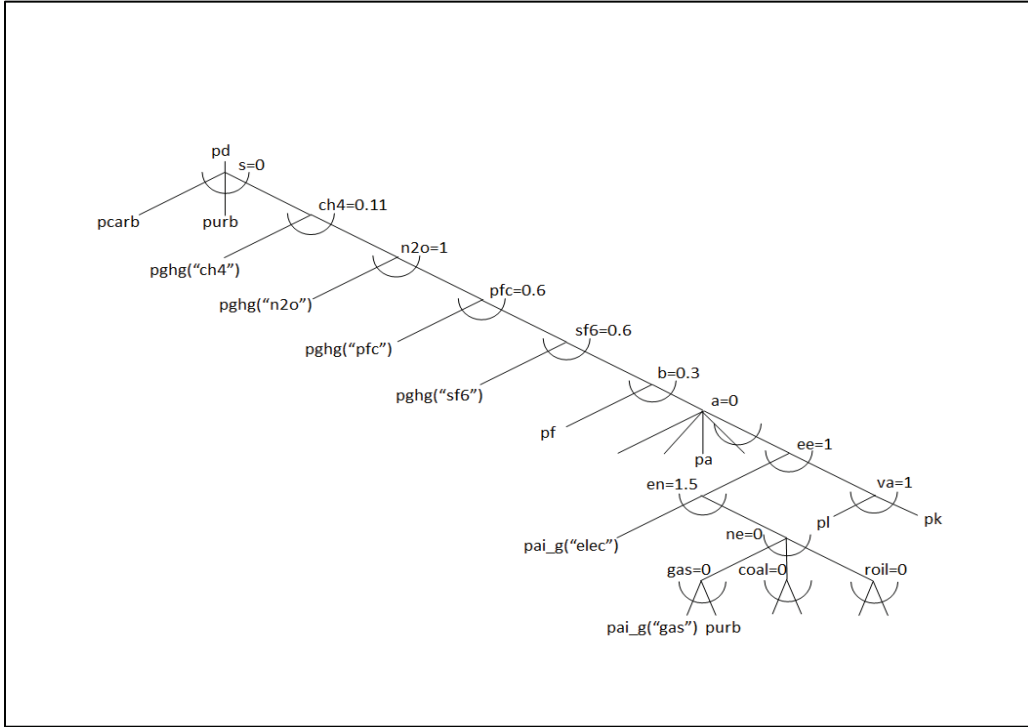
## APPENDIX C: OTHER PRODUCTION STRUCTURES



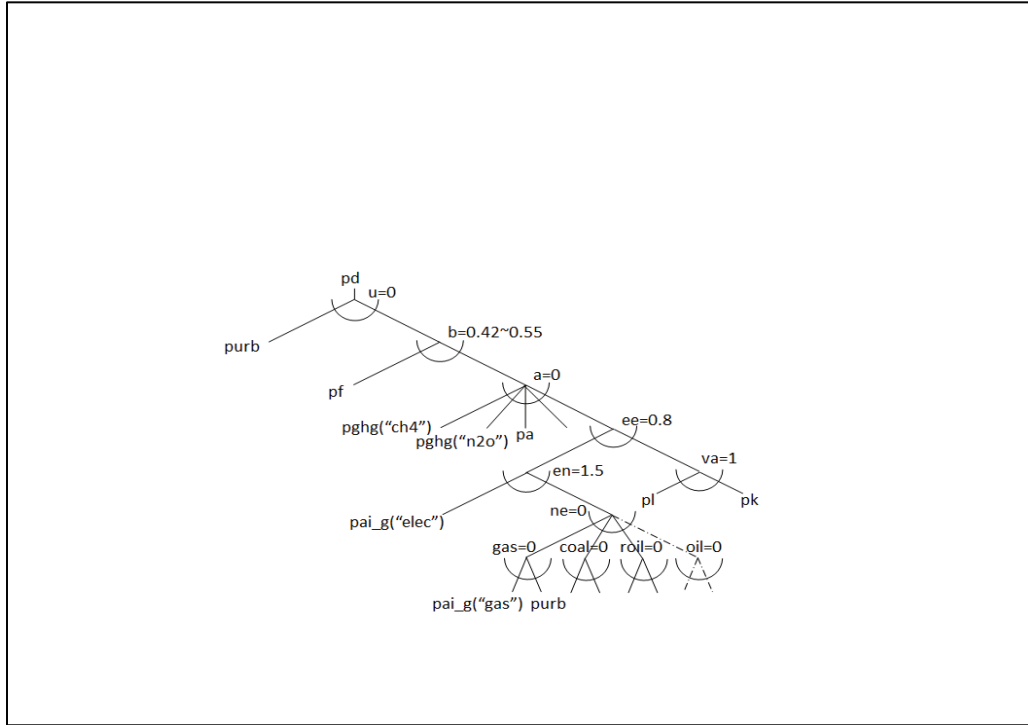
**Figure C1.** Production structure for CROP, LIVE, and FORS.



**Figure C2.** Production structure for FOOD, OTHR, SERV, TRAN, and DWE.

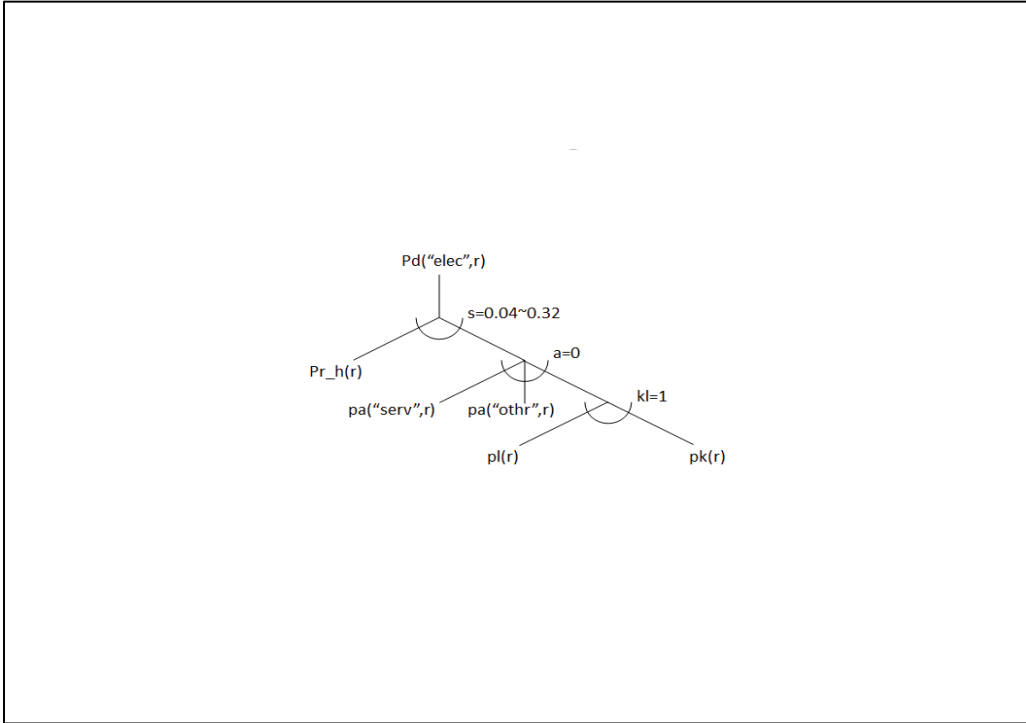


**Figure C3.** Production structure for EINT.

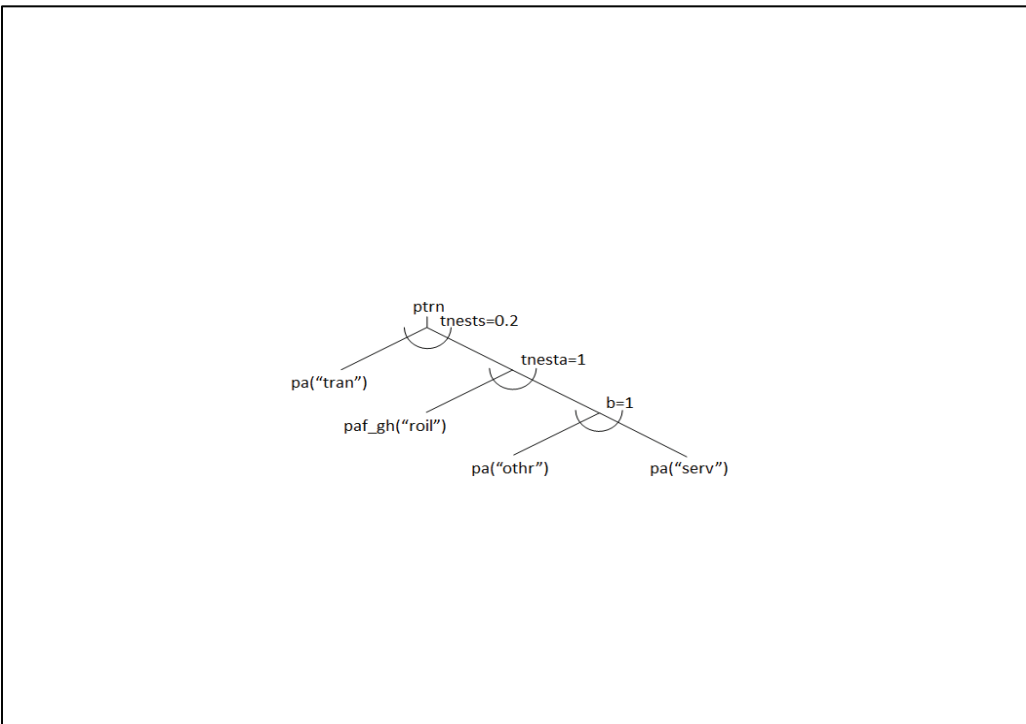


**Figure C4.** Production structure for COAL, OIL, ROIL, and GAS.





**Figure C5.** Production structure for hydro and nuclear generation.



**Figure C6.** Household transportation.

## APPENDIX D: REGIONAL AND SECTORIAL MAPPINGS (GTAP 8 TO EPPA6-L)

**Table D1.** Regional Mapping from GTAP 8 to EPPA6-L.

GTAP 8 region	EPPA6 region	GTAP 8 region	EPPA6 region
Albania	ROE	Mongolia	REA
United Arab Emirates	MES	Mozambique	AFR
Argentina	LAM	Mauritius	AFR
Armenia	ROE	Malawi	AFR
Australia	ANZ	Malaysia	ASI
Austria	EUR	Namibia	AFR
Azerbaijan	ROE	Nigeria	AFR
Belgium	EUR	Nicaragua	LAM
Bangladesh	REA	Netherlands	EUR
Bulgaria	EUR	Norway	EUR
Bahrain	MES	Nepal	REA
Belarus	ROE	New Zealand	ANZ
Plurinational Republic of Bolivia	LAM	Oman	MES
Brazil	BRA	Pakistan	REA
Botswana	AFR	Panama	LAM
Canada	CAN	Peru	LAM
Switzerland	EUR	Philippines	ASI
Chile	LAM	Poland	EUR
China	CHN	Portugal	EUR
Cote d'Ivoire	AFR	Paraguay	LAM
Cameroon	AFR	Qatar	MES
Colombia	LAM	Romania	EUR
Costa Rica	LAM	Russian Federation	RUS
Cyprus	EUR	Saudi Arabia	MES
Czech Republic	EUR	Senegal	AFR
Germany	EUR	Singapore	ASI
Denmark	EUR	El Salvador	LAM
Ecuador	LAM	Slovakia	EUR
Egypt	AFR	Slovenia	EUR
Spain	EUR	Sweden	EUR
Estonia	EUR	Thailand	ASI
Ethiopia	AFR	Tunisia	AFR
Finland	EUR	Turkey	ROE
France	EUR	Taiwan	ASI
United Kingdom	EUR	Tanzania, United Republic of	AFR
Georgia	ROE	Uganda	AFR
Ghana	AFR	Ukraine	ROE
Greece	EUR	Uruguay	LAM
Guatemala	LAM	United States of America	USA
Hong Kong	CHN	Venezuela	LAM
Honduras	LAM	Viet Nam	REA
Croatia	ROE	South Central Africa	AFR
Hungary	EUR	Rest of Central America	LAM
Indonesia	IDZ	Caribbean	LAM
India	IND	Central Africa	AFR
Ireland	EUR	Rest of East Asia	REA
Iran, Islamic Republic of	MES	Rest of Eastern Africa	AFR
Israel	MES	Rest of Eastern Europe	ROE
Italy	EUR	Rest of EFTA	EUR
Japan	JPN	Rest of Europe	ROE
Kazakhstan	ROE	Rest of North America	LAM
Kenya	AFR	Rest of North Africa	AFR
Kyrgyzstan	ROE	Rest of Oceania	ANZ
Cambodia	REA	Rest of South Asia	REA
Korea, Republic of	KOR	Rest of South African Customs Union	AFR
Kuwait	MES	Rest of Southeast Asia	REA
Lao People's Democratic Republic	REA	Rest of South America	LAM
Sri Lanka	REA	Rest of Former Soviet Union	ROE
Lithuania	EUR	Rest of the World	ANZ
Luxembourg	EUR	Rest of Western Africa	AFR
Latvia	EUR	Rest of Western Asia	MES
Morocco	AFR	South Africa	AFR
Madagascar	AFR	Zambia	AFR
Mexico	MEX	Zimbabwe	AFR
Malta	EUR		

**Table D2.** Sectorial Mapping from GTAP 8 to EPPA6-L.

GTAP 8 sector	EPPA6 sector	GTAP 8 sector	EPPA6 sector
paddy rice	CROP	wood products	OTHR
wheat	CROP	paper products - publishing	EINT
cereal grains nec	CROP	petroleum - coal products	ROIL
vegetables - fruit - nuts	CROP	chemical - rubber - plastic products	EINT
oil seeds	CROP	mineral products nec	EINT
sugar cane - sugar beet	CROP	ferrous metals	EINT
plant-based fibers	CROP	metals nec	EINT
crops nec	CROP	metal products	EINT
bo horses	LIVE	motor vehicles and parts	OTHR
animal products nec	LIVE	transport equipment nec	OTHR
raw milk	LIVE	electronic equipment	OTHR
wool - silk-worm cocoons	LIVE	machinery and equipment nec	OTHR
forestry	FORS	manufactures nec	OTHR
fishing	LIVE	electricity	ELEC
coal	COAL	gas manufacture - distribution	GAS
oil	OIL	water	OTHR
gas	GAS	construction	OTHR
minerals nec	OTHR	trade	SERV
bo meat products	FOOD	transport nec	TRAN
meat products	FOOD	water transport	TRAN
vegetable oils and fats	FOOD	air transport	TRAN
dairy products	FOOD	communication	SERV
processed rice	FOOD	financial services nec	SERV
sugar	FOOD	insurance	SERV
food products nec	FOOD	business services nec	SERV
beverages and tobacco products	FOOD	recreational and other services	SERV
textiles	OTHR	public admin, defence, education, health	SERV
wearing apparel	OTHR	ownership of dwellings	DWE
leather products	OTHR		

**Table D3.** Mapping of Production Factor from GTAP 8 to EPPA6-L.

GTAP 8 production factor	EPPA6 production factor	
Skilled labor	L	Labor
Unskilled labor	L	Labor
Capital	K	Capital
Land	Lnd	Land
Natural resources	FFA	Natural resource

## APPENDIX E: THE MODEL STRUCTURE

**Figure E1** provides an overview on how different components of EPPA6-L are sequentially executed. These components can be classified into the static component on the right (*eppaexec.gms*) and the dynamic component on the left (*eppalooop.gms*). For the static component, the main tasks include: 1) declaring set and parameters; 2) reading data (GTAP 8, elasticities, backstop technologies, exogenous trends, GHGs inventories, etc.); and 3) checking accounting balances and model calibration. The core of this component is the static CGE model (*eppacore.gms*). For this component, in addition to the zero profit, market clearing, and income balance conditions presented in Section 2, it also includes equations for calibrating the BAU productivity levels mentioned previously. The static component is written in MPSGE, which is a compact, non-algebraic language for building CGE models. MPSGE greatly reduces chances of programming errors and improves productivity when changing model settings, such as revising the CES nesting structures for various activities, or making model extensions to have new backstop technologies. Interested readers may refer to Rutherford (1999), Markusen and Rutherford (2004), and Markusen (2013) for details.

The dynamic component, which is written in GAMS, will perform a series of steps to implement the recursive dynamics discussed in Section 2, and these steps include 1) incorporating information about scenario settings (availability of backstop technologies, BAU or policy scenarios, etc.); 2) implementing recursive dynamics (resource evolutions, capital accumulations and vintage capital evolutions, exogenous trends, etc.); 3) solving the model; and 4) saving simulation results for each period.

**Figure E2** presents details for the dynamic component. In particular, it shows that for the BAU run, productivity levels are calibrated to match the given BAU GDP projections, which will be illustrated in Section 4. For all other runs, the calculated productivity levels are exogenously given, and the GDP levels are solved endogenously. More specifically, if no additional policies beyond BAU are added, with a correct calibration, the model replicates BAU GDP levels accurately when the productivity levels calculated previously are exogenously assigned.

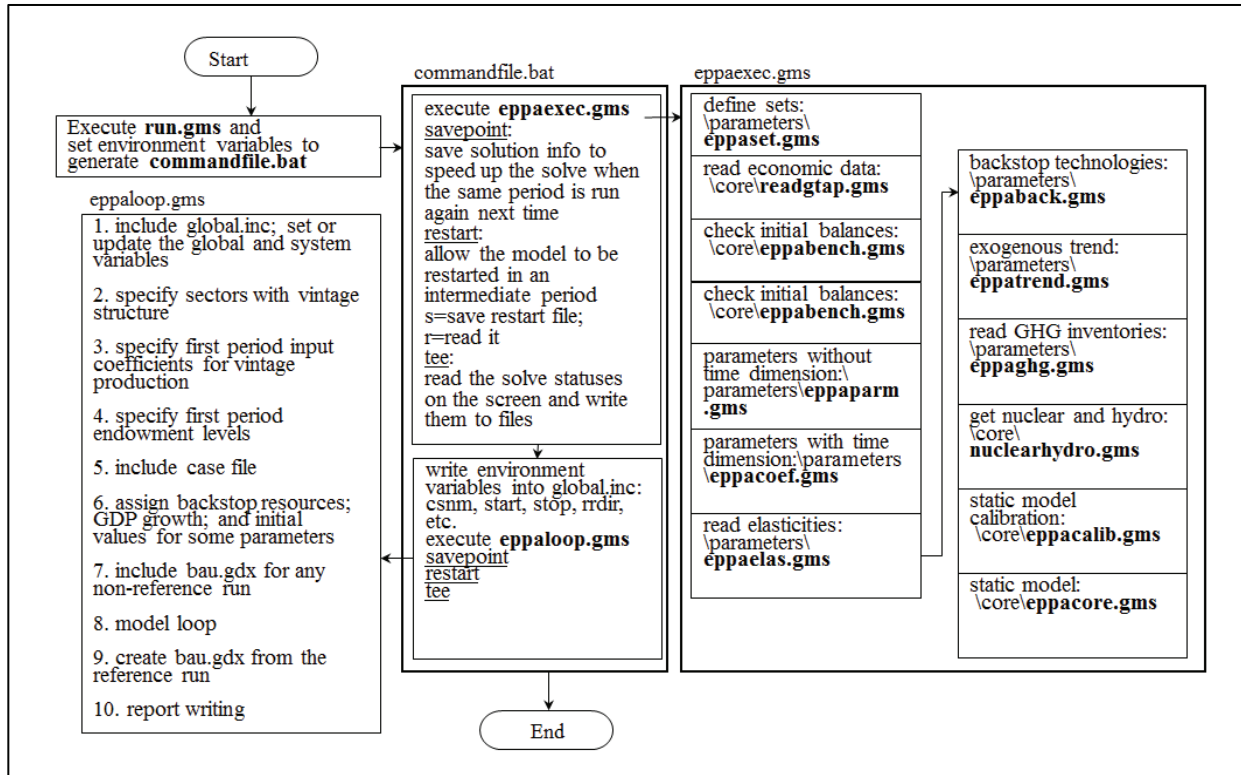


Figure E1. Model structure: flow chart for running EPPA6-L.

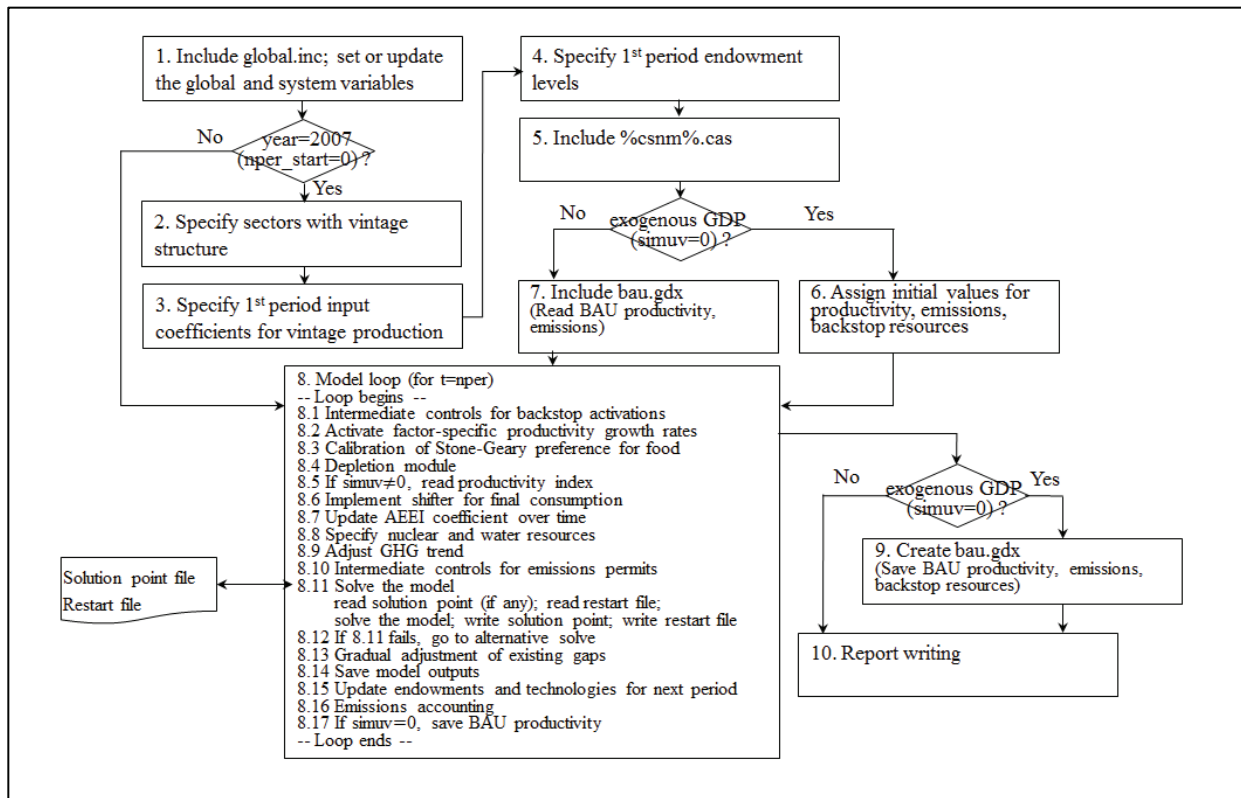


Figure E2. Model structure: recursive dynamics component (eppalooop.gms)

## REPORT SERIES of the MIT Joint Program on the Science and Policy of Global Change

FOR THE COMPLETE LIST OF JOINT PROGRAM REPORTS: <http://globalchange.mit.edu/pubs/all-reports.php>

238. **Market Cost of Renewable Jet Fuel Adoption in the United States.** *Winchester et al.*, January 2013
239. **Analysis of U.S. Water Resources under Climate Change.** *Blanc et al.*, February 2013
240. **Protection of Coastal Infrastructure under Rising Flood Risk.** *Lickley et al.*, March 2013
241. **Consumption-Based Adjustment of China's Emissions-Intensity Targets: An Analysis of its Potential Economic Effects.** *Springmann et al.*, March 2013
242. **The Energy and CO<sub>2</sub> Emissions Impact of Renewable Energy Development in China.** *Zhang et al.*, April 2013
243. **Integrated Economic and Climate Projections for Impact Assessment.** *Paltsev et al.*, May 2013
244. **A Framework for Modeling Uncertainty in Regional Climate Change.** *Monier et al.*, May 2013
245. **Climate Change Impacts on Extreme Events in the United States: An Uncertainty Analysis.** *Monier and Gao*, May 2013
246. **Probabilistic Projections of 21<sup>st</sup> Century Climate Change over Northern Eurasia.** *Monier et al.*, July 2013
247. **What GHG Concentration Targets are Reachable in this Century?** *Paltsev et al.*, July 2013
248. **The Energy and Economic Impacts of Expanding International Emissions Trading.** *Qi et al.*, August 2013
249. **Limited Sectoral Trading between the EU ETS and China.** *Gavard et al.*, August 2013
250. **The Association of Large-Scale Climate Variability and Teleconnections on Wind Resource over Europe and its Intermittency.** *Kriesche and Schlosser*, September 2013
251. **Regulatory Control of Vehicle and Power Plant Emissions: How Effective and at What Cost?** *Paltsev et al.*, October 2013
252. **Synergy between Pollution and Carbon Emissions Control: Comparing China and the U.S.** *Nam et al.*, October 2013
253. **An Analogue Approach to Identify Extreme Precipitation Events: Evaluation and Application to CMIP5 Climate Models in the United States.** *Gao et al.* November 2013
254. **The Future of Global Water Stress: An Integrated Assessment.** *Schlosser et al.*, January 2014
255. **The Mercury Game: Evaluating a Negotiation Simulation that Teaches Students about Science-Policy Interactions.** *Stokes and Selin*, January 2014
256. **The Potential Wind Power Resource in Australia: A New Perspective.** *Hallgren et al.*, February 2014
257. **Equity and Emissions Trading in China.** *Zhang et al.*, February 2014
258. **Characterization of the Wind Power Resource in Europe and its Intermittency.** *Cosseron et al.*, March 2014
259. **A Self-Consistent Method to Assess Air Quality Co-Benefits from US Climate Policies.** *Saari et al.*, April 2014
260. **Electricity Generation and Emissions Reduction Decisions under Policy Uncertainty: A General Equilibrium Analysis.** *Morris et al.*, April 2014
261. **An Integrated Assessment of China's Wind Energy Potential.** *Zhang et al.*, April 2014
262. **The China-in-Global Energy Model.** *Qi et al.* May 2014
263. **Markets versus Regulation: The Efficiency and Distributional Impacts of U.S. Climate Policy Proposals.** *Rausch and Karplus*, May 2014
264. **Expectations for a New Climate Agreement.** *Jacoby and Chen*, August 2014
265. **Coupling the High Complexity Land Surface Model ACASA to the Mesoscale Model WRF.** *Xu et al.*, August 2014
266. **The CO<sub>2</sub> Content of Consumption Across US Regions: A Multi-Regional Input-Output (MRIO) Approach.** *Caron et al.*, August 2014
267. **Carbon emissions in China: How far can new efforts bend the curve?** *Zhang et al.*, October 2014
268. **Characterization of the Solar Power Resource in Europe and Assessing Benefits of Co-Location with Wind Power Installations.** *Bozonnat and Schlosser*, October 2014
269. **A Framework for Analysis of the Uncertainty of Socioeconomic Growth and Climate Change on the Risk of Water Stress: a Case Study in Asia.** *Fant et al.*, November 2014
270. **Interprovincial Migration and the Stringency of Energy Policy in China.** *Luo et al.*, November 2014
271. **International Trade in Natural Gas: Golden Age of LNG?** *Du and Paltsev*, November 2014
272. **Advanced Technologies in Energy-Economy Models for Climate Change Assessment.** *Morris et al.*, December 2014
273. **The Contribution of Biomass to Emissions Mitigation under a Global Climate Policy.** *Winchester and Reilly*, January 2015
274. **Modeling regional transportation demand in China and the impacts of a national carbon constraint.** *Kishimoto et al.*, January 2015.
275. **The Impact of Advanced Biofuels on Aviation Emissions and Operations in the U.S.** *Winchester et al.*, February 2015
276. **Specifying Parameters in Computable General Equilibrium Models using Optimal Fingerprint Detection Methods.** *Koesler*, February 2015
277. **Renewables Intermittency: Operational Limits and Implications for Long-Term Energy System Models.** *Delarue and Morris*, March 2015
278. **The MIT EPPA6 Model: Economic Growth, Energy Use, and Food Consumption.** *Chen et al.*, March 2015