

**Modelling the Global Prospects and Impacts of Heavy Duty
Liquefied Natural Gas Vehicles in Computable General Equilibrium**

by

Arthur Hong Chun Yip

Bachelor of Applied Science in Chemical Engineering
University of Waterloo, 2012

Submitted to the Engineering Systems Division
in Partial Fulfillment of the Requirements for the Degree of

Master of Science in Technology and Policy

at the

Massachusetts Institute of Technology

June 2014

© 2014 Massachusetts Institute of Technology. All Rights Reserved.

Signature of Author:

Engineering Systems Division
May 30, 2014

Certified by:

Dr. Sergey V. Paltsev
Principal Research Scientist
Assistant Director for Economic Research
MIT Joint Program on the Science and Policy of Global Change
Thesis Supervisor

Accepted by:

Prof. Dava J. Newman
Professor of Aeronautics and Astronautics and Engineering Systems
Director, Technology and Policy Program

Modelling the Global Prospects and Impacts of Heavy Duty Liquefied Natural Gas Vehicles in Computable General Equilibrium

by

Arthur Hong Chun Yip

Submitted to the Engineering Systems Division
in Partial Fulfillment of the Requirements for the Degree of

Master of Science in Technology and Policy

at the

Massachusetts Institute of Technology

Abstract

Natural gas vehicles have the prospects of making substantial contributions to transportation needs. The adoption of natural gas vehicles could lead to impacts on energy and environmental systems. An analysis of the main factors and trends that affect adoption of natural gas vehicles such as vehicle costs, infrastructure costs, and fuel economics was performed. The fuel cost analysis showed that assuming production and distribution at scale, liquefied natural gas (LNG) can be competitive as a diesel fuel substitute for heavy duty vehicles in the US, and also in EU and China. A methodology of incorporating heavy duty natural gas vehicles into a computable general equilibrium (CGE) economic modelling was developed to investigate the potential adoption and impacts. Modelling variables such as vehicle and infrastructure costs were tested and several scenarios were applied to examine the general equilibrium impacts on natural gas vehicle adoption and the general equilibrium impacts of resulting natural gas vehicle adoption. Climate policy scenarios were also developed and tested. In the base case scenario, results showed significant adoption of LNG trucks (Class 8) in the US, with 10% penetration of heavy duty trucks by 2020 and up to 100% by 2040. In China and the EU, adoption was projected to be slower due to higher natural gas prices. In the US, introduction of LNG trucks resulted in moderately higher natural gas prices, slightly lower oil prices, and a small reduction in total GHG emissions, relative to scenarios without LNG truck availability. The development of natural gas fuelled transportation is still in its infancy and CGE modelling offers a tool that can be applied to test a wide range of assumptions of cost development and relative prices.

Thesis Supervisor:

Dr. Sergey V. Paltsev
Principal Research Scientist
Assistant Director for Economic Research
MIT Joint Program on the Science and Policy of Global Change

Acknowledgements

Thank you to:

Sergey, for his guidance through EPPA and this research work

BP, Andrew, and Rosie, for their financial support and helpful discussion

My friends and colleagues at the MIT Joint Program on the Science and Policy of Global Change, including John, Jake, Fannie, Robert, Tony, Henry, Jen, Valerie, Paul, Rebecca, DJ, Claudia, Michael, Amanda, for their contributions to an excellent interdisciplinary, collaborative, and supportive research environment

My friends and colleagues in TPP and ESD, including Jesse, Michael, Ash, Michael, Rodrigo, and the faculty and staff of TPP, ESD, and MIT, especially Barb, Ed, and Frank, for their roles in a collegial environment and the best academic program and entity at MIT

The research groups at the MIT Energy Initiative, China Energy and Climate Project, Center for Energy and Environmental Policy Research, and Professor John Heywood's Sloan Automotive Lab, for their openness and opportunities for collaboration

MIT, for its generous support for student activities and graduate research

My family, for their encouragement of my graduate studies

Dolly, for her everlasting care and support

Sean-Paul, for reminding me to look forward

Table of Contents

1	Introduction.....	8
2	The Landscape for Natural Gas as a Transportation Fuel.....	10
2.1	Scope and Overview.....	10
2.2	Light Duty Natural Gas Vehicles.....	14
2.3	Heavy Duty Natural Gas Vehicles.....	17
2.4	Natural Gas Fuel and Infrastructure.....	19
2.4.1	Storage Technology.....	19
2.4.2	CNG and LNG Production.....	20
2.4.3	CNG and LNG Distribution.....	22
2.4.4	Current Progress.....	24
2.5	Fuel Economics.....	27
2.5.1	Natural Gas Feedstock.....	27
2.5.2	CNG Cost Analysis.....	28
2.5.3	LNG Cost Analysis.....	31
2.6	Fuel Savings and Payback.....	33
2.7	Externalities.....	34
2.7.1	Climate Externality.....	35
2.7.2	Air Quality Externality.....	35
2.7.3	Energy Security Externality.....	36
2.8	Policies and Trends.....	36
2.9	Implications for Modelling.....	38
3	Modelling Heavy Duty LNG Vehicles in Computable General Equilibrium (CGE).....	40
3.1	General Equilibrium Modelling.....	40
3.2	The MIT Emissions Prediction and Policy Analysis (EPPA) Model.....	41

3.3	Modelling New Transportation Technologies in EPPA	44
3.4	Disaggregation and Segmentation.....	45
3.5	Cost Structure	48
3.6	Mark-up Factor	51
3.7	Technology-Specific Factor.....	53
3.8	Uncertainty in Mark-up Factor	56
3.9	Adoption Results under Variation in Mark-up Factor.....	60
3.10	Business-As-Usual Scenario Effects and Impacts	62
3.11	Policy Scenario Effects on Adoption	64
4	Conclusions	67
5	References	69

List of Figures and Tables

Figure 1: US transportation energy consumption split by mode, 2012.....	10
Figure 2: Passenger travel mode share in various regions in 2012.....	11
Figure 3: Light duty natural gas vehicles and their fleet share by country	12
Figure 4: Heavy duty natural gas vehicle (CNG and LNG) adoption by country	13
Figure 5: Distribution of LNG infrastructure in the United States	21
Figure 6: Distribution of LNG import terminals and liquefaction plants in China	22
Figure 7: CNG fuelling station schematic.....	23
Figure 8: LNG fuelling station schematic	24
Figure 9: LNG fuelling stations in China	27
Figure 10: CNG cost breakdown, assuming production at scale	30
Figure 11: LNG cost breakdown, assuming production at scale	32
Figure 12: MIT Emissions Prediction and Policy Analysis model	42
Figure 13: Nested structure of producer sectors in EPPA	43
Figure 14: Nested structure of consumer sectors in EPPA	43
Figure 15: Existing transportation sector in EPPA	46
Figure 16: Disaggregated transportation sector in EPPA with backstop technology sector representing LNG trucks.....	47
Figure 17: Inputs to the transportation sector in EPPA and corresponding inputs to Class 8b trucking	48
Figure 18: Derivation of the input shares for the LNG truck backstop technology sector.....	49
Figure 19: Result of testing mark-up variation on adoption rate of LNG truck backstop technology.....	53

Figure 20: Illustrative examples of technology adoption.....	54
Figure 21: Historical adoption rates of vehicle technologies	56
Figure 22: Estimates of incremental cost for class 7 & 8 combination tractor trailer trucks.....	57
Figure 23: Capital expenditures for historical LNG liquefaction facilities.....	59
Figure 24: Time frames for 10% LNG truck penetration milestone in selected regions	61
Figure 25: LNG truck adoption as share of Class 8 segment, as share of natural gas consumption in the region, and as share of transportation fuel consumption in the region.....	62
Figure 26: Impacts of LNG truck adoption on GHG and prices in the US, relative to reference scenario and prices without LNG trucks.....	64
Figure 27: LNG truck adoption under climate policy scenarios.....	65
Figure 28: Natural Gas Consumption by LNG trucks under climate policy scenarios	66
Table 1: Sample comparisons of retail and conversion prices of light duty CNG vehicles and gasoline counterparts.....	16
Table 2: Sample comparisons of the cost of heavy-duty CNG and LNG vehicles and their diesel counterparts	19
Table 3: Estimated payback periods for different vehicle types	34

1 Introduction

Since the energy crises of the 1970's, alternative fuel vehicles (AFVs) have been considered as a solution to relieve petroleum dependence (USDOT, 2002).

Increased environmental concerns due to carbon emissions and air pollution from vehicle exhaust have also helped place alternative transportation fuels on the public agenda. Synthetic fuels, biofuels, natural gas, hydrogen, and electricity have all been considered as alternatives to the dominant petroleum-based fuels of gasoline and diesel. With persistently high petroleum prices and significant shifts in natural gas markets around the world, there has been renewed interest in the natural gas option. For example, in recent addresses, US President Obama has specifically included natural gas vehicles and fuelling stations as part of his vision for the United States¹ (Obama, 2014).

There are three key compelling drivers for an increased usage of natural gas as a transportation fuel. The first is the expectation of a long-term price differential between natural gas fuel and conventional petroleum-based fuel in the United States, given the new supply outlook of shale and unconventional gas (EIA, 2013), and also in some other regions to a lesser extent. The US Department of Energy projects that on a retail fuel price basis, compressed natural gas (CNG) fuel could cost 40% to 60% below the equivalent amount of diesel through 2040 in the United States (DOE, 2012). The second driver is the potential to improve energy security via the displacement of petroleum and the mitigation of geopolitical and economic risks of petroleum dependence. The third motivation is the benefit of emissions reduction for air quality and for climate change. Natural gas generally burns more cleanly and less carbon-intensively than petroleum-based fuels and this can lead to reduced tailpipe emissions that pollute the air and impact the climate.

However, these direct benefits must be weighed against their corresponding costs and overall impacts. A shift to natural gas vehicles could change the dynamics of supply and demand of natural gas, and also of oil, coal, and associated GHG. How

¹ 2014 State of the Union Address: "...*putting people to work building fueling stations that shift more cars and trucks from foreign oil to American natural gas...*"

might natural gas vehicle (NGV) adoption impact energy prices, energy flows, energy trade, and global greenhouse gas emissions? Furthermore, how would these impacted factors affect NGV adoption in return? Then, how might natural gas vehicle adoption respond to trends and policies and then also affect and impact the policy targets themselves? For example, natural gas has many competing and growing demands and applications that also promise improved energy security and emissions reduction. In the electric power sector, natural gas increasingly serves as an economical and environmentally-friendlier substitute to coal when burned in combined cycle power plants and could also serve as a valuable complement to intermittent renewable power sources. Natural gas is also consumed by households and commercial buildings for winter heating and hot water and by industry as boiler fuel and chemical feedstock. Natural gas is increasingly being traded internationally via pipelines and liquefied natural gas (LNG) tankers. How do the prospects of natural gas for transportation fit in this larger picture? What role and impact would NGVs have in this picture if natural gas is to be a bridge to a low-carbon future? One approach, top-down general equilibrium economic modelling, can help inform these big-picture engineering systems questions of complex causality, feedback, large-scale and long-term change, and sustainability.

This thesis investigates the global prospects and impacts of LNG as an alternative transportation fuel for heavy duty vehicles. First, I present a comprehensive overview of the main factors and trends that affect adoption of natural gas vehicles in different regions of the world and construct a cost analysis of natural gas fuel options. This will inform the near-term potential and long-term prospects of natural gas use in multiple types of vehicles. Building on this knowledge base, the next section develops the general equilibrium modelling approach and the assumptions used to represent the prospects and impacts of heavy duty LNG vehicles, a specific application of natural gas use in transportation. This section integrates and tests several assumptions and modelling variables to create a base case analysis of adoption under a business-as-usual scenario. I then discuss the simulation results from several scenarios that are applied to examine the general equilibrium impacts on natural gas vehicle adoption and the general equilibrium impacts of resulting natural gas vehicle adoption.

2 The Landscape for Natural Gas as a Transportation Fuel

2.1 Scope and Overview

Natural gas is a versatile energy resource. There are many technology and fuel pathways for natural gas to serve as an alternative transportation fuel. Natural gas can be used directly in its compressed (CNG) or liquefied (LNG) form, or it may be used in transportation indirectly via conversion to synthetic fuels such as methanol, ethanol, dimethyl ether, or even gasoline or diesel, or via conversion to hydrogen or electricity and use in fuel cell electric vehicles or plug-in electric vehicles. The scope of this section and thesis is limited to the direct use of natural gas fuel.

Transportation modes and segments are also diverse. Figure 1 shows a breakdown of transportation fuel use between different modes in the US for 2012. The two largest segments are on-road light duty vehicles (LDVs) consuming 55% of total transportation fuel and on-road heavy duty vehicles (HDVs) at 21%. While rail, marine, and off-road applications (drilling rigs, mining trucks) also show significant promise, they make up a relatively small proportion of fuel consumption as shown in Figure 1. This section and thesis focuses on the on-road LDV and HDV transportation segments.

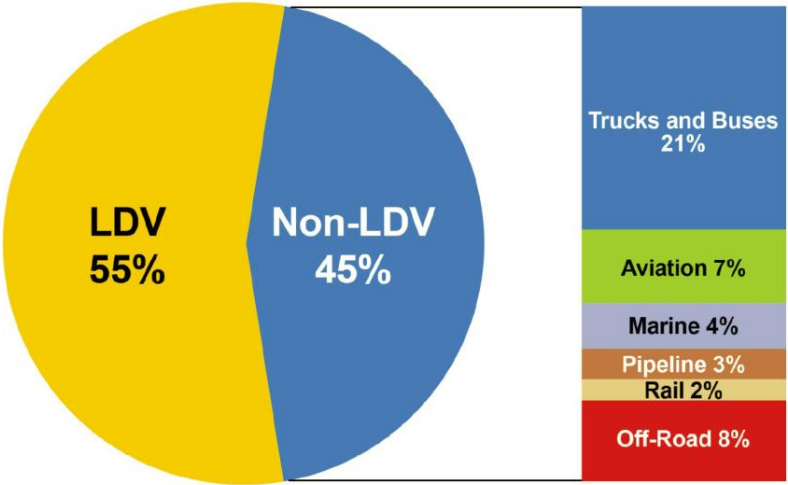

Figure 1: US transportation energy consumption split by mode, 2012

Source: EIA, 2013.

Different modes of transportation have wide-ranging mileage and fuel use patterns and the modal split varies significantly by world region. As seen in Figure 2, passenger transport (measured in passenger-kilometers travelled) is supplied mostly by passenger cars and passenger light trucks in the US, EU, and Japan. Buses and trains (and 2-wheelers) provide substantially larger shares of passenger transportation in regions such as Latin America, China and India. Freight also varies significantly by mode and region. With heterogeneous vehicle types across regions, adoption of NGVs will also vary region by region.

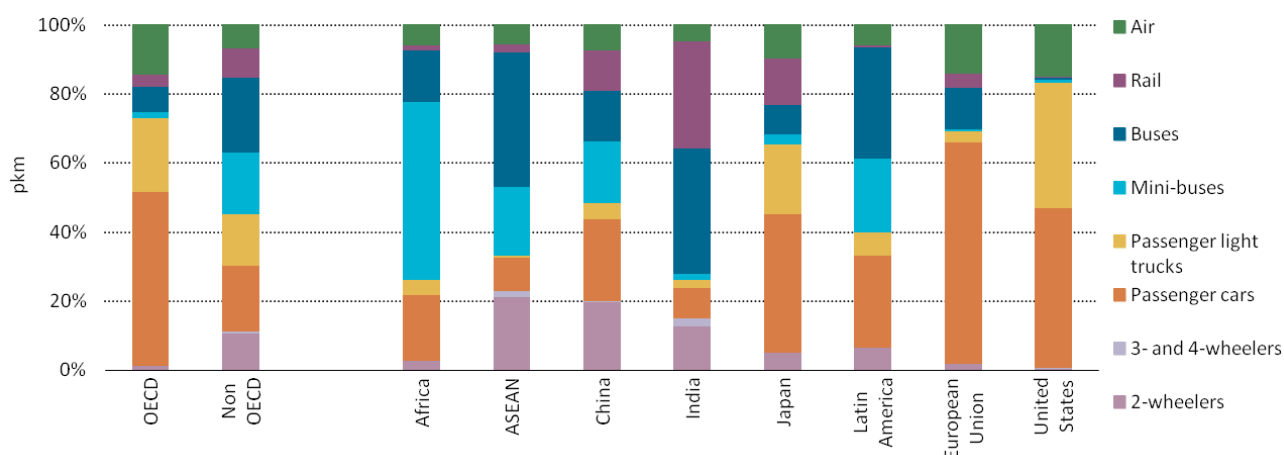

Figure 2: Passenger travel mode share in various regions in 2012

Source: IEA, 2012.

Both light and heavy duty segments have already experienced varied levels of adoption of natural gas fuel around the world. As of May 2014, an estimated 18 million light duty vehicles (LDV) worldwide² exist with natural gas fueling capability (NGV Communications, 2014). In Figure 3, it can be seen that natural gas vehicles in the world are concentrated in a few countries. Iran and Pakistan have notable numbers of passenger vehicles retrofitted with small compressed natural gas (CNG) tanks to take advantage of relatively lower cost and subsidized domestic fuel (NGV Global, 2011). Other Asian and South American countries with significant adoption include Argentina, China, Brazil, and India. Air quality and emissions reduction have

² There are approximately 1 billion light duty vehicles in the world today, meaning LD NGVs represent approximately 1-2% of the total vehicle stock, concentrated in the countries shown in Figure 3.

been the other strong motivation for NGV adoption. Commercial and government fleets, including taxis, shuttles, utility vans, cargo vans, and pickup trucks around the world have adopted NGVs under strong government support via vehicle incentives, fuel subsidies, and infrastructure construction. For example, in the US, companies such as UPS, AT&T, Waste Management, and Chesapeake Energy have adopted LD and HD NGVs for their fleets.

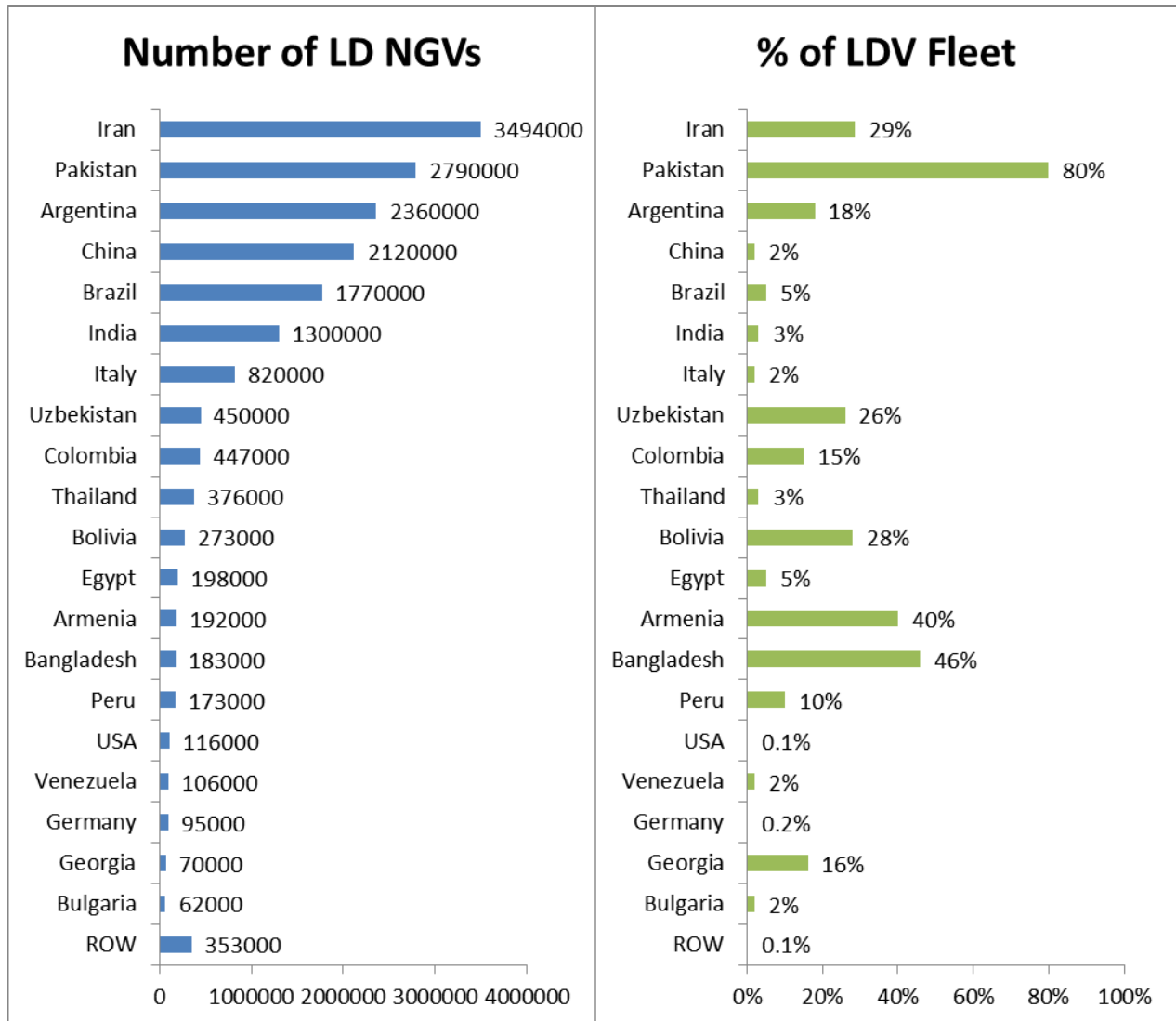

Figure 3: Light duty natural gas vehicles and their fleet share by country

Source: NGV Communications, 2014. Most countries reporting 2014 or 2013 estimates. Excludes two-wheelers; includes motorized three-wheelers.

As of May 2014, a global total of 2 million natural gas vehicles are classified as medium or heavy duty trucks and buses, which would include vehicles such as delivery vans, mini-buses, transit buses, school buses, garbage trucks, and a wide variety of freight trucks (NGV Communications, 2014). Several countries are leading in their adoption of natural gas for heavy duty vehicles, including China, India, and Ukraine, shown in Figure 4. The estimated 880,000 number of natural gas buses and trucks in China represent approximately 4% of total number of buses and trucks, whereas in the United States, the 56,000 number of natural gas buses and trucks represent approximately 0.5% of the heavy duty vehicle segment fuel consumption³ (NGV Communications, 2014).

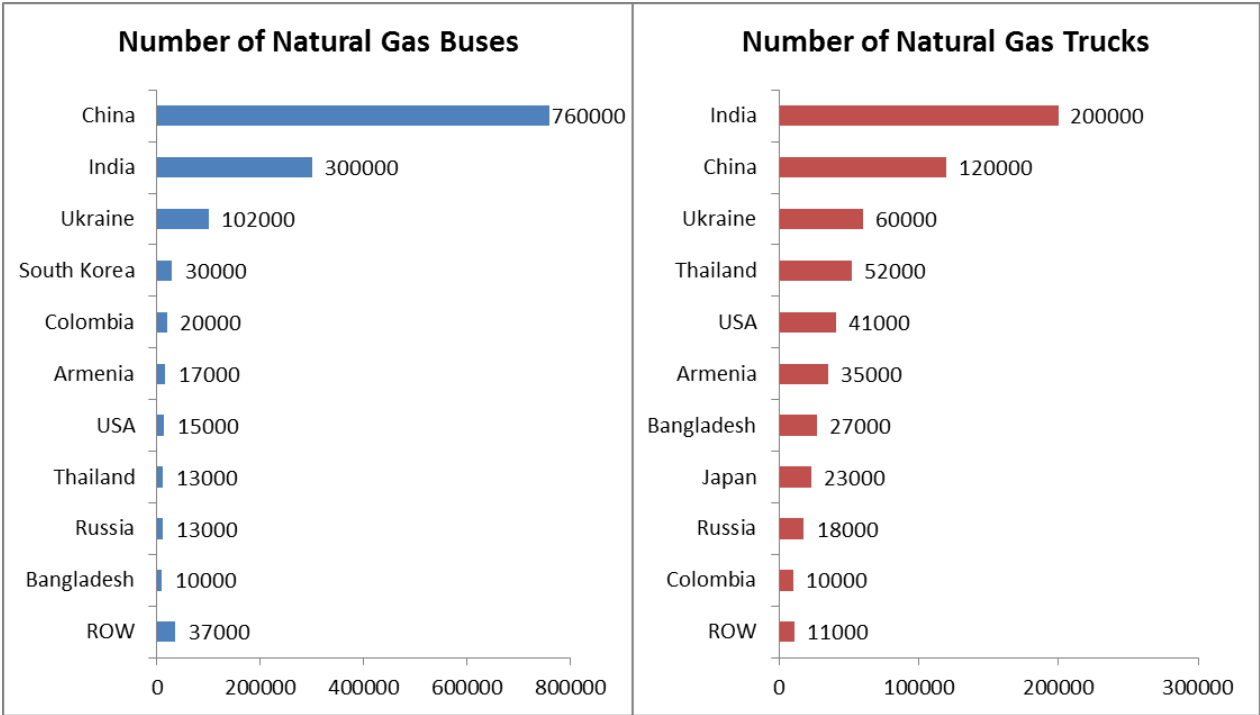

Figure 4: Heavy duty natural gas vehicle (CNG and LNG) adoption by country

Source: NGV Communications, 2014. Most countries reporting 2014 or 2013 estimates. Includes both CNG and LNG.

One increasingly important vehicle segment for potential natural gas penetration is the heavy-duty long-haul freight trucks and semi-tractors. This will be made possible with the use of liquefied natural gas (LNG) instead of compressed natural

³ Heavy duty vehicle statistics are difficult to compare due to the varied methods of vehicle classification.

gas (CNG). Although LNG tanks and infrastructure are more expensive than corresponding CNG technology, the use of LNG has the advantages of liquid fuel use, including the provision of vehicle range comparable to conventional vehicles, quick refuelling times, and flexibility of fuel supply. At last count in 2011, there were 3100 LNG trucks in the US (DOE, 2014). Since 2011, there have been several large commitments to deploy LNG trucks as the infrastructure becomes available, with the largest being from UPS - 700 LNG tractors by the end of 2014 (UPS, 2014). Meanwhile, an estimated 80,000 of the HD NGVs in China are LNG-fuelled, as of 2013 (Beveridge, 2013).

2.2 Light Duty Natural Gas Vehicles

One of the advantages of natural gas as an alternative fuel for vehicles is its compatibility with conventional internal combustion technology. Natural gas can be used to fuel spark-ignition engines and can provide comparable performance and efficiency within 10% of conventional gasoline fuelled vehicles. Known fuel economy measures and technologies such as downsizing, turbo-charging, and direct-injection, as well as future advances in combustion technology will mostly be applicable to natural gas engines. Variable valve timing, cylinder deactivation, electronic returnless fuel systems, six speed transmissions, and stop/start hybridization are all enhancements that can apply to natural gas vehicles. However, because CNG tanks already carry a premium and because natural gas is already a relatively cleaner fuel, some of these features will not be implemented due to the trade-off between fuel economy and vehicle cost. The cost-effectiveness of the technology addition, vehicle emissions standards, and consumer demand would guide the design of an NGV with the appropriate fuel economy enhancing features.

Light duty NGVs exist in several variants. One configuration is the dedicated mono-fuel natural gas vehicle, which would operate only on natural gas. The other configuration is the bi-fuel vehicle, which would carry both gasoline and natural gas in separate tanks to be used in the same internal combustion engine. Another distinction for NGVs is whether they are designed and built to run on natural gas by the original equipment manufacturer (OEM) or if they are converted to natural gas on the aftermarket.

In the US and Europe, mechanics who are authorized by the OEMs to convert vehicles ensure that vehicles maintain their warranty and meet environmental and safety certifications. Dealerships often partner with these licensed mechanics and shops to deliver a turnkey solution for customers at purchase. This option is termed “Qualified Vehicle Modification” (QVM). Meanwhile, in Asia and South America, the aftermarket bi-fuel conversion option is dominant. Existing vehicle fleets have converted quickly with the availability of inexpensive aftermarket kits and in the absence of strict regulations on vehicle modifications, emissions, and safety. An estimated 90% of the light duty NGVs in Latin America and South Asia are bi-fuel conversions (Pike Research, 2011). Conversions will usually result in a bi-fuel vehicle to retain fuel flexibility and to avoid unnecessary modifications. In contrast, about 90% of the NGVs in the US are dedicated (mono-fuel) NGVs (Murphy, 2009).

Several automotive OEMs, particularly in Europe, offer natural gas versions of their vehicle models. Volkswagen, Fiat, Ford, and GM/Opel offer many bi-fuel models based on existing (liquefied petroleum gas) LPG bi-fuel models. In the US, the Honda Civic CNG is the only OEM model currently offered as an NGV, but other OEMs have been partnering with QVMs to offer conversion-ready and turn-key solutions for models such as the Chevrolet Impala, Ford Super Duty pickup trucks, Chevrolet Silverado, GMC Sierra, Ford E-250/350, Chevrolet Express Cargo van, and GMC Savana Cargo van. New for 2014 will be popular models including Ford F-150 and Chevrolet Cruze CNG, a sign that OEMs are seeing opportunities for natural gas vehicles in the US.

OEMs have offered CNG vehicles in the US in the past. From 1996 to 2004, models such as Toyota Camry, Ford Crown Victoria, Ford F-150, Dodge Caravan, and Honda Civic were available with natural gas powertrains. This history of OEMs offering NGVs can be attributed to the Energy Policy Act of 1992 that mandated alternative fuel vehicles (Rubin & Leiby, 2000).

The cost differential between conventional vehicles and CNG vehicles can be estimated by the difference in retail prices of equivalent vehicles models presented in Table 1 for selected models and countries. The prices vary significantly: an aftermarket conversion in Pakistan will typically add about 10% to the retail price of

a car, while the OEM price difference in different regions is about 16-29%; conversions by QVMs in Europe add 12-16%; and conversions by QVMs in USA add 28-33% to the retail price of a gasoline-based car.

Table 1: Sample comparisons of retail and conversion prices of light duty CNG vehicles and gasoline counterparts

Model	Location	OEM/ conversion	Tank Capacity (GGE ^b)	Retail Price ^a		Premium	%
				Gasoline	CNG		
Suzuki Cultus	Pakistan	Conversion	3 (bi-fuel)	\$ 7,200	\$ 7,600	\$ 400	6%
Volkswagen Suran	Argentina	Conversion	3 (bi-fuel)	\$ 11,300	\$ 12,500	\$ 1,200	11%
Ford Focus	Italy	Conversion by QVM	6 (bi-fuel)	\$ 28,600	\$ 32,000	\$ 3,400	12%
Volkswagen Golf	Czech Republic	OEM	4 (bi-fuel)	\$ 25,000	\$ 29,000	\$ 4,000	16%
Ford Focus	Germany	Conversion by QVM	6 (bi-fuel)	\$ 28,600	\$ 33,300	\$ 4,700	16%
Honda Civic	USA	OEM	8	\$ 18,000	\$ 23,300	\$ 5,300	29%
GM/Opel Zafira	Germany	OEM	10	\$ 30,000	\$ 36,800	\$ 6,800	23%
Volkswagen Passat	Germany	OEM	8 (bi-fuel)	\$ 34,900	\$ 42,600	\$ 7,700	22%
Ford F150 NG	USA	Conversion by QVM	21	\$ 24,000	\$ 32,000	\$ 8,000	33%
Chevrolet Impala	USA	Conversion by QVM	11	\$ 25,000	\$ 33,000	\$ 8,000	32%
Ford Focus	Sweden	Conversion by QVM	6 (bi-fuel)	\$ 25,700	\$ 34,900	\$ 9,200	36%
Ford F250 NG	USA	Conversion by QVM	25	\$ 34,000	\$ 43,500	\$ 9,500	28%

a Prices at retail as of 2013, converted to USD, without incentives or taxes. Pricing from OEM website quoted MSRP, QVM websites, Pakistan NGV Association, Argentina NGV Association, aggregated in NPC (National Petroleum Council) Report, 2013, Macquarie, 2012, Lux Research, 2012.

b Gallon Gasoline Equivalent of energy in natural gas

One main factor behind the variation in prices and premiums is the tank capacity. Bi-fuel NGVs and converted NGVs typically carry a small tank with limited natural gas range while retaining gasoline capability. Dedicated NGVs depend on the CNG tank for all trips and distances. This vehicle attribute is highly relevant to the

consumer's convenience and likelihood of adoption. Similar to electric vehicles, natural gas vehicles suffer from reduced range due to the lower energy density of natural gas compared to petroleum-based fuels.

Whether the vehicle is an aftermarket or retrofit conversion or an OEM-designed vehicle also makes a big difference. Retrofits in Asia and Latin America are relatively inexpensive, in part due to differences in location, economics of scale, and labour cost. The fuel system retrofit is likely to affect engine efficiency, fuel leakage, emissions, as well as quality, performance, and safety. In the US, conversions are expensive due to the requirement of one-time safety and emission certifications for each vehicle model and each vehicle modifier. Finally, differences in cost can be attributed to tank and fuel system safety and quality standard.

In the US, with further engine and vehicle fuel system optimization, design, and integration, and taking into account existing technological experience and maturity of combustion engines and fuel storage, and expected technological progress, the cost of the retail price premium for a OEM CNG vehicle may fall significantly. According to the National Petroleum Council (2013), for a small car in the USA, today's premium of \$5000 - \$9000 could be expected to fall to \$3600 by 2020 and \$2700 by 2040, assuming a high volume of production of carbon fibre tanks and related components, as well as reduced costs of certification when production is at scale.

2.3 Heavy Duty Natural Gas Vehicles

Heavy duty vehicles also come in several variants. While almost all are dedicated NGVs, HD NGVs may store their fuel as CNG or LNG when the mileage of the vehicle makes the investment worthwhile. Around the world, many municipalities have adopted natural gas-fuelled transit buses, school buses, and garbage trucks, with the objectives of reducing air pollution and fuel costs. Freight companies have started to test and purchase fleets of tractor trailers with natural gas engines. Most heavy duty vehicles are built to order while engine manufacturers such as Cummins and Westport supply the natural gas engines.

Two choices exist for heavy duty natural gas engines: spark ignition (SI) and compression ignition (CI). For spark ignited (SI) natural gas (NG) engines, operation is similar to a conventional gasoline engine with CNG or LNG instead of gasoline fuel injection. Manufacturers typically adapt existing diesel engine blocks to retain structural robustness and durability. Spark plugs and an air flow throttle are added and the compression ratio, air-fuel ratio, and exhaust gas recirculation are recalibrated for spark ignition. In the US, the SI NG engine is estimated to cost \$3000 - \$7000 more than a comparable diesel engine, and by 2015, the net incremental price of an SI NG engine compared to a diesel engine may be at a premium of \$3000 or even a cost advantage of \$2200, based on the simplicity of the engine fuel system and the savings from avoided diesel after-treatment equipment (NPC, 2013). However, the SI NG engine suffers from a 10-15% fuel efficiency penalty (compared to a CI diesel engine) (Westport, 2013) and a corresponding emissions penalty.

The other engine option, compression ignition, operates similarly to a diesel engine, and requires a small amount (5%) of diesel as an ignition source along with 95% LNG. The main advantage of this technology is that it can provide performance equal to diesel, but at significantly higher cost, at \$26,000 to \$39,000 more than a diesel engine (NPC, 2013) (Westport, 2013). However, there is strong support by truck OEMs and customers for continued development of this type of alternative fuel engine that can provide fuel cost savings with high performance, and the industry expects further cost reductions and improved choice in engine size and performance. Currently, this option faces strong competition from new developments in SI natural gas engines that carry a much smaller premium and can meet most performance needs.

Besides the additional engine cost, the new fuel tanks carrying CNG or LNG are expected to contribute significantly to the premium of a heavy duty natural gas vehicle. Table 2 shows a sample of the retail and estimated prices of natural gas truck variants.

Table 2: Sample comparisons of the cost of heavy-duty CNG and LNG vehicles and their diesel counterparts

Vehicle	Estimated Retail Price ^a		Premium	%
	Diesel	CNG/LNG		
Transit bus (CNG) (class 7)	\$ 300,000	\$ 325,000	\$ 25,000	8%
Garbage truck (CNG) (class 6)	\$ 220,000	\$ 260,000	\$ 40,000	18%
Tractor trailer (SI, LNG) (class)	\$ 125,000	\$ 175,000	\$ 50,000	40%
Truck (SI, LNG) (China)	\$ 80,000	\$ 95,000	\$ 15,000	20%

a Price estimates from Macquarie 2012, Frost and Sullivan 2012, Lux Research 2012, CNPC 2013.

2.4 Natural Gas Fuel and Infrastructure

2.4.1 Storage Technology

For most duty cycles and range requirements, compressed natural gas (CNG) stored in pressurized tanks is the fuel of choice. Liquefied natural gas (LNG) may be suitable for high fuel consumption applications such as heavy-duty long haul trucks due to its compact form.

The main difference between a conventional vehicle and a natural gas vehicle is its fuel tank. While CNG is compressed at 200 bar, its volumetric energy density is still only 60% of gasoline. The tank size involves a trade-off between vehicle attributes such as range, efficiency (due to weight), cargo capacity, and cost. A bi-fuel CNGV mitigates the range concern but suffers from further efficiency penalties. Full OEM design allows for better integration of the tank into the vehicle platform, which would reduce efficiency and volume concerns. CNG tanks come in a range of materials, from "type I" steel composite to "type IV" carbon fibre tanks. The trade-off involves a less bulky tank (in weight and volume) so that there is adequate room for cargo.

LNG tanks are vacuum-insulated cryogenic tanks that are kept under -162 C. LNG tanks are much lighter and take up much less volume than those of CNG, making them suitable for heavy duty vehicles requiring large fuel tank capacities. Although LNG tanks and infrastructure are more expensive than corresponding CNG technology, the use of LNG has the advantages of liquid fuel use, including the provision of vehicle range comparable to conventional vehicles and quick refuelling times. LNG is also more easily transported as a liquid fuel in tanker trucks.

2.4.2 CNG and LNG Production

Natural gas is a well-established energy resource with mature supply chains and markets in many parts of the world. It is produced and transported globally via pipeline or tanker. Natural gas is also stored in underground reservoirs, pipeline fill, and LNG facilities.

Compared with other fuels, natural gas requires relatively simple processing and treatment before its use as a fuel. The main value added is in the compression or liquefaction processes. The processes to produce CNG and LNG, multi-stage compression and cryogenic liquefaction, are mature technologies.

CNG is produced on demand and at the point of refueling. Natural gas is accepted from the distribution pipeline, de-moisturized, and then compressed into on-site storage, which would be used to dispense CNG at the appropriate pressure.

LNG on the other hand is usually produced centrally at liquefaction plants. LNG is currently produced on a large scale at export terminals. LNG is also produced at peak shaving and storage facilities that have been used by utility companies to meet peak natural gas demand. LNG is typically transported by tanker on a large scale and by truck on a small scale. Although liquefaction capacity will need to expand as LNG demand increases, initial demand could be served by underutilized capacity at peak shaving facilities and export liquefaction facilities. There are also opportunities within natural gas infrastructure systems to add small-scale liquefaction facilities where natural gas is depressurized from the trunk pipeline to local gas distribution networks, where natural gas is processed to separate natural gas liquids and to reject nitrogen, and where biogas from landfills or digesters is cleaned up and treated (TIAX, 2012).

LNG import terminals may also be considered an important source of LNG fuel for transportation. The advantage of this source would be that the natural gas would already be in liquefied form, resulting in significant savings because the cost of liquefaction would have already been accounted and paid for. Some technical difficulties exist, including the issue that imported LNG may be of a different quality needed for LNG vehicles, and the requirement that LNG be viably transported by

truck from import terminals to where it is needed, with some remote or offshore terminals being inaccessible. However, given the large cost savings from avoided liquefaction, the economic activity of coastal populations and settlements, and the commitments from major economies such as China to import increasing amounts of natural gas via LNG despite the cost, the direct supply of LNG from import terminals may serve the initial and long-term growth of LNG vehicle fleets.

In the United States, three LNG plants have been built for the purpose of serving transportation fuel markets, in Boron, CA, Topock, AZ, and Willis, TX, shown in Figure 5. Other LNG facilities include gas processing facilities, LNG for utility storage, and export and import terminals. In China, state-owned enterprises and private companies have been constructing many LNG terminals and liquefaction plants. Figure 6 shows the widespread distribution of LNG infrastructure in China.

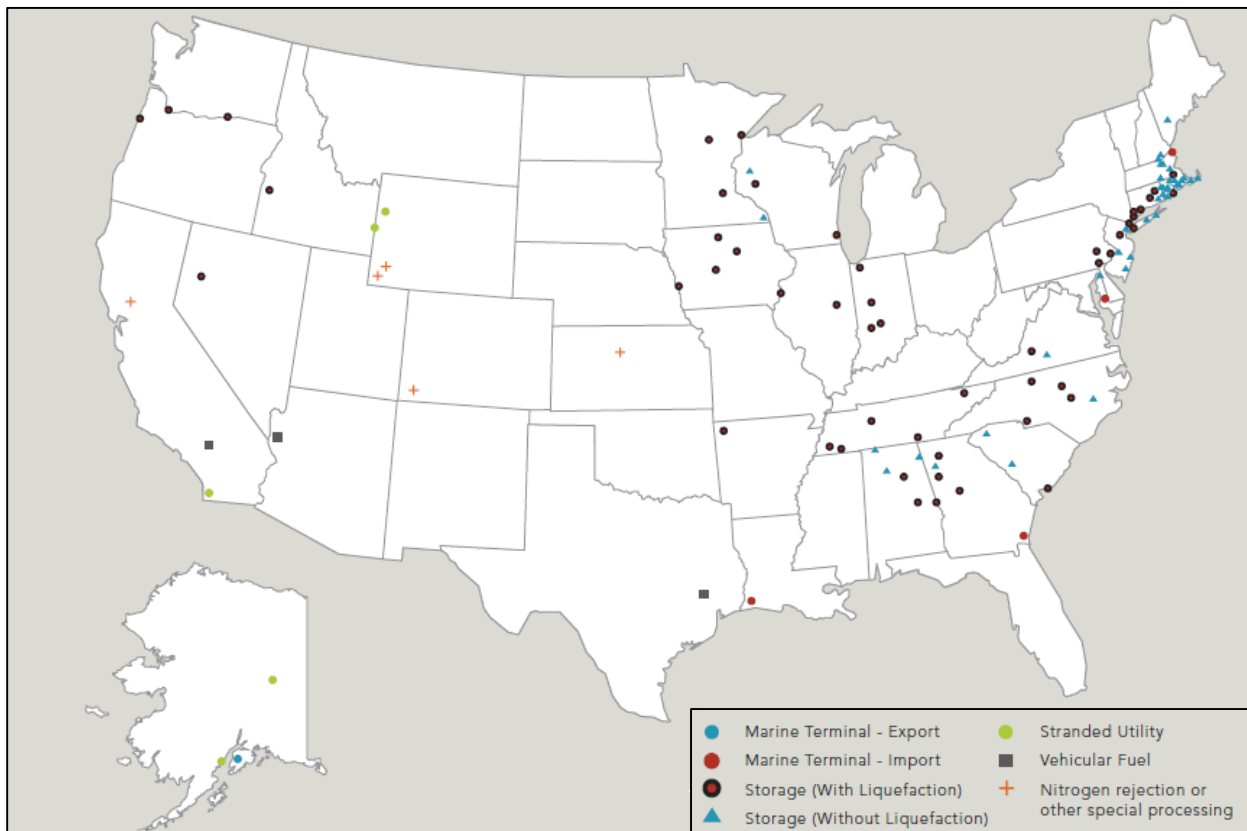

Figure 5: Distribution of LNG infrastructure in the United States

Source: US EIA and TIAX, from TIAX (2012)

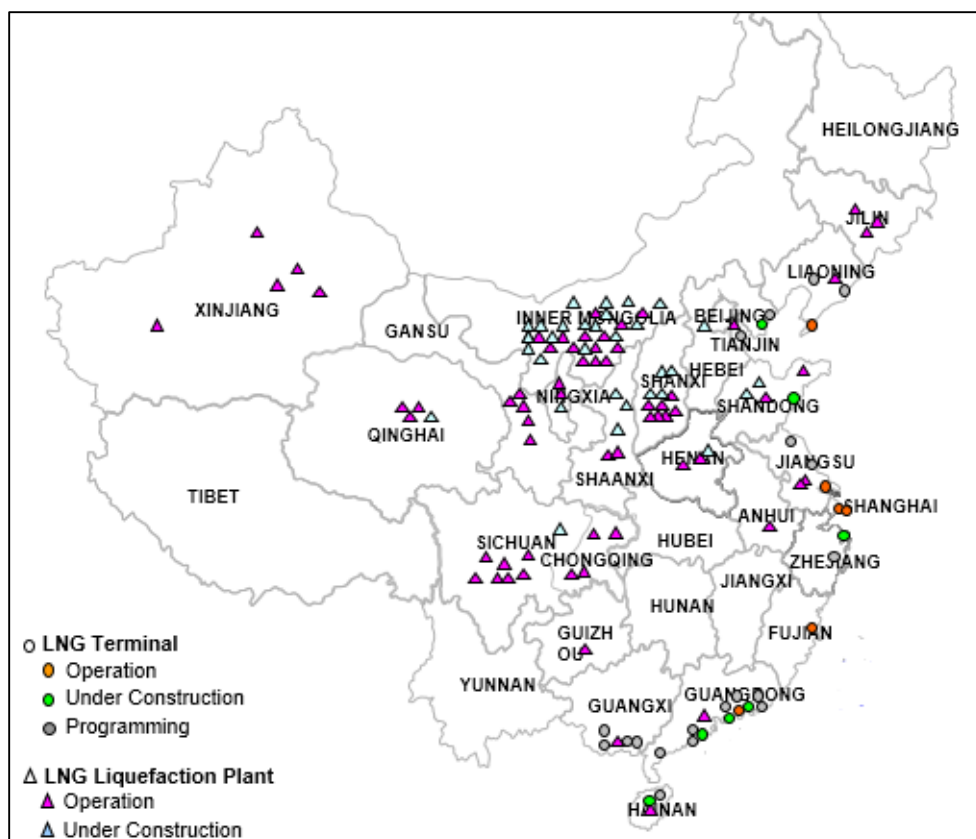

Figure 6: Distribution of LNG import terminals and liquefaction plants in China

Source: China Natural Gas Industry Magazine, from Westport (2013)

While the current liquefaction capacity in the United States is negligible compared to existing natural gas and transportation fuel demands, the liquefaction capacity in China was estimated to serve roughly 7 percent of Chinese natural gas demand in 2010, for both infrastructure bridging and transportation fuel purposes (Reuters, 2011).

2.4.3 CNG and LNG Distribution

There are several methods to dispense CNG and LNG. For CNG, the typical public fuelling station employs the fast-fill method involving vehicles refueling at a rate of 8 GGE (Gasoline Gallon Equivalent) per minute from high pressure buffer storage that has been built up by the on-site natural gas compressor. This is shown in Figure 7. This method can be deployed at a new-build dedicated station or at a modular dispensing unit that can be added to an existing gasoline station.

CNG Station

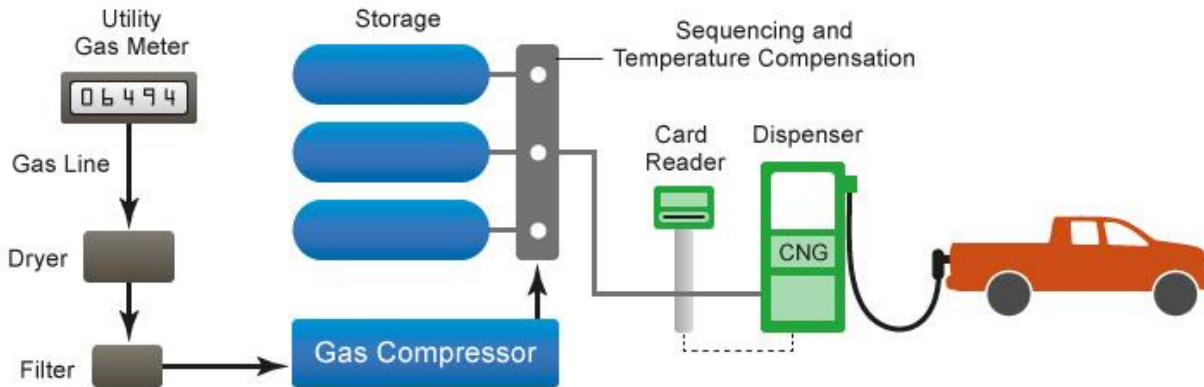

Figure 7: CNG fuelling station schematic

Source: DOE, 2014

An alternative method used by medium and heavy-duty CNG fleets today is the time-fill method, in which transit buses and garbage trucks fill up overnight at low pressure. This method makes use of a smaller compressor and does not require on-site high pressure storage tanks, which results in lower capital costs. These stations can fuel at a rate of 4 GGE per hour, thereby limiting this method to fleets that return and park at a home base every night. The time-fill method can also be performed with a home refueling system connected to the local natural gas distribution network. Home refueling could improve the availability of CNG fuel to consumers and has parallels to home charging for plug-in electric vehicles. This could alleviate infrastructure requirements. The primary drawback to home refuelling is the cost of a personal fuelling device and the limited fueling rate of 1 GGE per hour, which constrains this option to overnight refueling.

LNG stations, on the other hand, are simpler than CNG stations, because they are “analogous” to conventional gasoline or diesel stations, with fuel produced at a centralized facility and distributed via tanker trucks and networks of stations (NPC, 2013). LNG fuel deliveries are stored in large insulated tanks and a pump dispenses LNG on demand. This configuration is shown in Figure 8. Many LNG stations also have extra equipment that can draw off stored LNG to supply CNG. Protective clothing, a face shield, and gloves are required to dispense LNG safely (DOE, 2014).

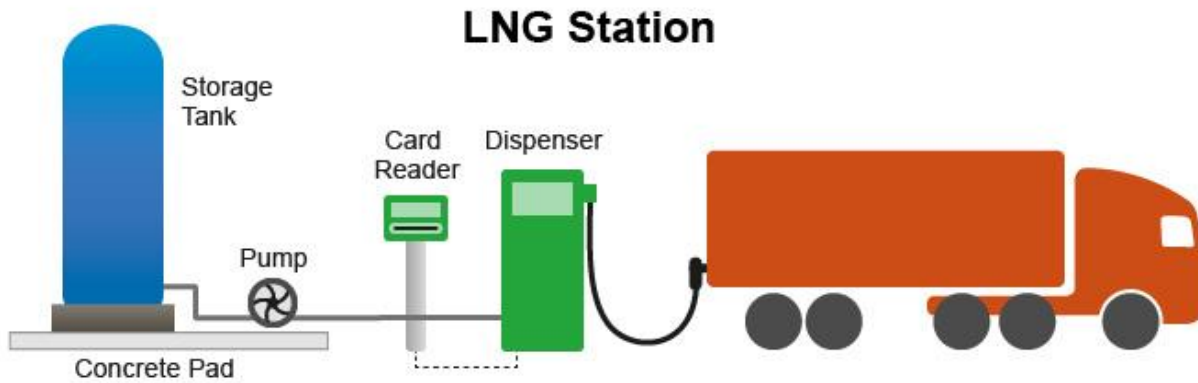

Figure 8: LNG fuelling station schematic

Source: DOE, 2014

2.4.4 Current Progress

Alternative fuel station deployment suffers from the oft-repeated “chicken and egg” dilemma that describes the uncertainty in timing of station building and vehicle purchases and wider adoption that dissuades either party from committing to the vehicle or station that depend on each another. For light duty natural gas vehicles, potential mitigation may be possible with the adoption of bi-fuel vehicle models that can fuel and run on either CNG or gasoline.

Commercial or government fleets (taxis, vans, buses, trucks) have been observed to adopt NGVs ahead of private household drivers due to the availability of private refueling infrastructure or a central refueling location that can be used by all members of that fleet. However, for adoption beyond fleets, a critical mass of stations will need to exist to serve a widespread vehicle population, as well as to convince drivers that they will be able to fill up when needed.

One suggested measure is the ratio of natural gas fueling stations to existing gasoline stations. Yeh (2007) observed that 10-30% market penetration was necessary in historical markets for wider adoption to take place.

In the US, as of May 2014, there are 1345 CNG stations, with approximately 50% of them private (DOE, 2014). There are significant clusters in California, New York, Oklahoma, Utah, and Texas, and in urban centers. The density of these clusters can

enable local and regional adoption without needing the entire country to meet certain metrics or ratios of adoption. As demand increases, some private stations serving fleets may be able to open up to serve the public to earn extra sales or add a dispensing unit outside of a restricted area. So far, many CNG station in the US are run by the local natural gas distribution company. It is likely these distribution companies add the capital costs of refueling stations into the overall rate base which is recovered via rate-of-return regulation and pricing (TIAX, 2012).

In comparison, there are 153,000 gasoline stations in the US (DOE, 2014). This means that CNG stations (including private stations) have a 0.9% presence compared to gasoline stations. Many of these stations, however, represent sunk capital built in response to the Energy Policy Act of 1992 (TIAX, 2012) and likely do not have enough customers to support a healthy return of capital. In fact, between 1997 and 2007, the number of CNG stations in the US fell from 1430 to 720 (DOE, 2014). With the advent of shale gas, the number of new stations has been growing once again (DOE, 2014).

In most if not all countries with natural gas vehicle adoption, CNG stations have been built with significant government participation via infrastructure incentives and tax credits, due to its high capital cost and uncertain number of customers initially. A CNG station with compression, storage, and dispensing equipment (and with the potential need for a spare compressor for reliability) carries a hefty price tag in the range of \$0.8-1.5 million (TIAX, 2012) (NPC, 2013). Meanwhile, an LNG fuelling station would also require a similar capital investment of \$1-2 million (NPC, 2013), but would have the capacity to serve four times as much fuel, assuming typical fuel station traffic.

In the US, as of May 2014, there are 92 LNG stations in total (40% private) (DOE, 2014). Clean Energy Fuels Corp. backed by T. Boone Pickens has been a proponent of LNG corridors (America's Natural Gas Highway) along the most-travelled freight routes in the US. His targets and plans have been deferred multiple times, but have seen some progress over the years. Other companies such as Shell and ENN Energy Holdings from China have also entered the market of supplying LNG in the US. For the heavy-duty market segment, deployment numbers can be compared to the

36,000 diesel fueling stations at truck stops or depots along transport corridors in the US, indicating a market penetration of 0.3% (TIAX, 2012). Significant challenges remain in the infrastructure build-out, given the large investments needed to create a critical mass in a distributed network of fuelling stations. Large truck stops and fleet depots can be targeted initially for the highest return on capital. State and federal governments have been asked to provide incentives, tax credits, and subsidies to help develop the infrastructure. Similarly, in Europe, “Blue Corridors” of natural gas have been proposed to run from Portugal to Sweden and Croatia (IGU, 2012), and in Asia, “Green Highways” have been proposed to run from Iran to Korea and Malaysia (IGU, 2012).

In China, there has been a very strong push from the national government to deploy natural gas fuelling infrastructure, especially LNG stations. As of 2013, there were 3350 CNG stations, and more notably, 1844 LNG stations (China Energy News, 2014), as shown in Figure 9. The 12th Five Year Plan (2011-2015) includes a target of 5000 LNG stations. LNG station construction has been described to be at “中國速度” or “China speed” by one newspaper (China Energy News, 2014), with deployment led by the three major Chinese oil and gas state-owned enterprises: China National Petroleum Corporation (CNPC) (also doing business as PetroChina and via subsidiary Kunlun Energy), China Petroleum and Chemical Corporation (Sinopec), and China National Offshore Oil Corporation (CNOOC); joined by private energy companies such as ENN Energy Holdings, Xinjiang Guanghui Industry Investment Group, and Hanas New Energy Group based in Ningxia and Shandong. PetroChina and Kunlun have been deploying a “gas-for-oil substitution” strategy since 2011 (CNPC, 2013). Natural gas for these stations has been sourced from conventional gas fields, as well as coke oven gas, coalbed methane, and LNG terminals. Provinces large and small, including Shandong, Henan, Sichuan, Hebei, Shaanxi, Shanxi, Qinghai, Hubei, Inner Mongolia, Xinjiang, Hainan, and Guizhou all have LNG stations under construction (China Energy News, 2014) (CNPC, 2013).

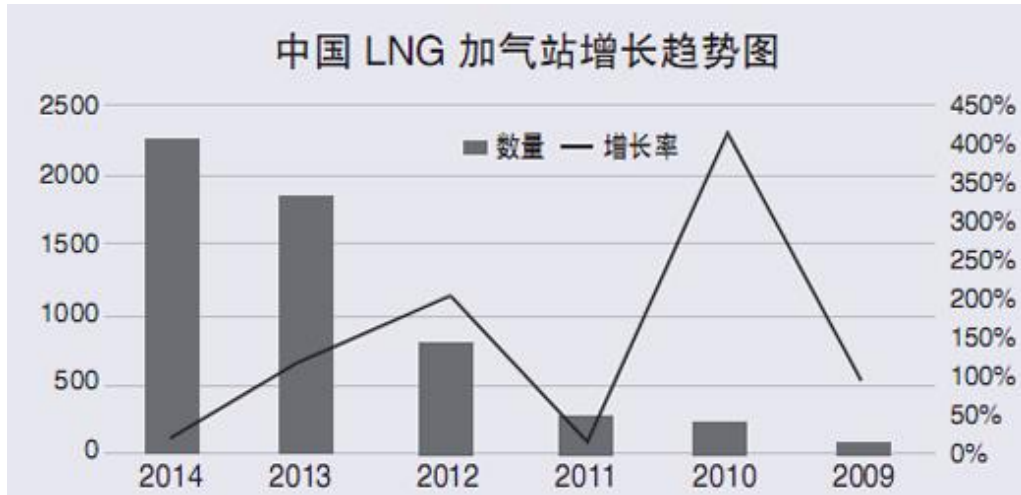

Figure 9: LNG fuelling stations in China

Source: China Energy News, 2014. Bars (left axis) represent number of LNG stations (2014 estimated); line (right axis) represents annual growth rate of LNG stations.

2.5 Fuel Economics

CNG and LNG are transportation fuels that require manufacturing or processing from natural gas feedstock, and also transport, distribution, and dispensing. This means that the cost of CNG and LNG should be decomposed into feedstock cost, amortized capital investment, and operating expenses. The price will also include taxes and profits.

2.5.1 Natural Gas Feedstock

The relationship between fuel cost and commodity cost is important to understand, because natural gas is supplied at very different prices around the world and at different points in time when looking into the future. In the US, natural gas is expected to remain at low cost due to a large resource base of unconventional gas. In Europe and Asia, natural gas prices are much higher, due to limited supply and the additional cost of imports via pipeline and LNG tanker. Prices for imported LNG are often contractually linked to the price of crude oil. With the continued development of global trade in LNG, regional prices may begin to converge to a global commodity price like crude oil, but subject to transportation costs between LNG markets.

New sources of gas are also anticipated in the future, including shale and unconventional gas around the world, renewable biogas, synthetic gas from coal, and methane hydrates, and they have varying costs and qualities. Competing demands will exert pressure on natural gas pricing. Natural gas is increasingly demanded in all sectors of the economy, including electric power, industry, and households. Finally, natural gas is increasingly traded via pipeline and LNG tanker.

Europe purchased natural gas from Russia's Gazprom at an average price of \$10.78/MMBTU in 2013 (Bloomberg, 2014), and China has reportedly negotiated a similar price for new pipeline imports from Siberia in its recently signed major contract with Russia. In the US, natural gas spot prices (Henry Hub) have approached \$5.00/MMBTU, rebounding from lows of \$2.55 in 2012 (DOE, 2014). Recently, a cold February and March in 2014 pushed US natural gas spot prices to \$7.90/MMBTU (DOE, 2014).

While the price of the feedstock may vary widely, a large component of the total cost can be attributed to the capital investment and operating costs of compression and liquefaction, as shown in the following cost decomposition analysis. It is useful to think of compression and liquefaction analogous to the refining process, in which raw commodity energy is manufactured into a vehicle fuel. This means that the appropriate comparison of prices is on a fuel-to-fuel basis, rather than a comparison of crude oil to natural gas prices.

2.5.2 CNG Cost Analysis

The National Petroleum Council Future of Transportation Fuels Futures study (2013) and the TIAX LLC reports (2010, 2012) commissioned by America's Natural Gas Alliance industry group made several estimates of the costs of CNG and LNG fuel in the United States⁴, based on recent construction costs and on interviews. A fast-fill

⁴ Internationally, some natural gas markets and infrastructure are not as developed as they are in the United States. Natural gas transmission and distribution networks may require new construction, expansion, or upgrades. Another factor is that regions dependent on LNG imports experience gas traded at prices that are indexed and coupled to oil prices. Government intervention in prices is also common. Nijboer (2010) in an IEA analysis estimates that the transmission and distribution cost component (conflated with CNG compression station capital and operating costs) could range from \$0.38/GGE (Gasoline

high capacity public CNG station was assumed to be the long-term solution at scale⁵.

Using estimates of capital equipment requirements and service level assumptions, the cost of supplying CNG was constructed and shown in Figure 10. Prices are in units of USD\$/GGE (Gallon Gasoline Equivalent). The retail price of CNG as offered in the US over the past 13 years and a similar cost breakdown of gasoline are plotted for comparison. For reference, as of May 2014, natural gas prices are around \$5/MMBTU in the US and \$10/MMBTU in the EU and China (without subsidy), while crude oil prices are around \$100/barrel.

Gallon Equivalent) in a region with a “highly developed transmission and distribution and retail network” to an extreme of \$4.92/GGE assuming no natural gas infrastructure (starting from scratch). These figures would overwhelm the other cost components as shown in the following analysis, but it is unlikely that vehicle fuel providers would bear the entire cost of natural gas transmission infrastructure and the demands from other sectors should drive investments in natural gas infrastructure.

⁵ The time-fill method for CNG can be inexpensive but limited in function, as it can only serve fleet vehicles overnight – school buses, garbage trucks, and transit buses, for example. These applications are particularly suited for time-fill CNG because of their fixed routes and fixed running schedules. An estimate of the amortized capital cost of this option amounts to \$0.15/GGE (TIAX, 2012), which is much more economical than a public fast-fill CNG station. This contributes to early adoption in the bus and garbage truck segments. The time-fill method can also be adapted as a home refueling option for light duty vehicles, but this can cost \$3000-5000 (TIAX, 2012). Due to the low fuel consumption of personal vehicles (12000 mi/yr ~ 500 GGE/yr), the amortized capital cost per GGE would be equivalent to adding \$1.20/GGE, which would likely eliminate most of the fuel price advantage over gasoline.

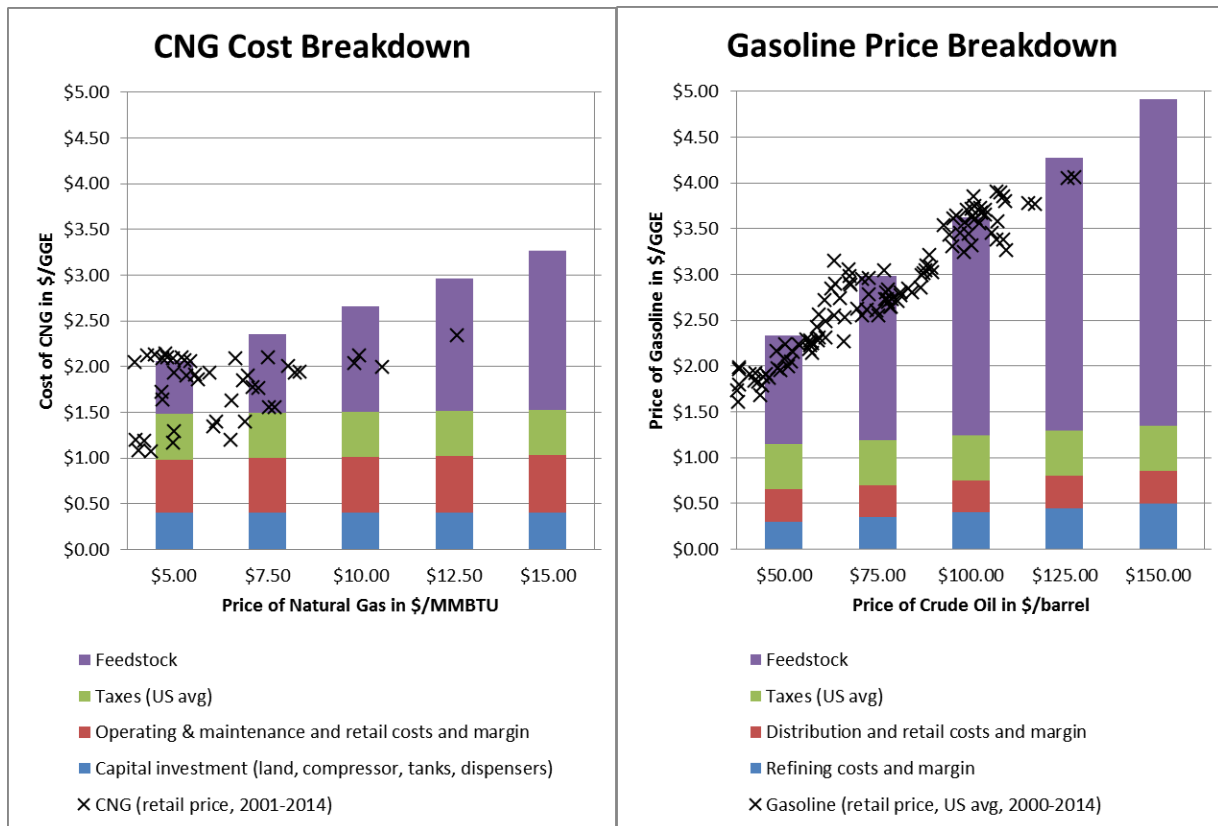

Figure 10: CNG cost breakdown, assuming production at scale

Box 1: Assumptions for CNG Cost

Feedstock: Calculation basis of 0.115540 MMBTU/GGE (Gasoline Gallon Equivalent) and 42 gallons/barrel of oil.

Taxes: Assumption of equivalent per-energy-content taxation of CNG and of gasoline; CNG is currently discounted or rebated.

Operating & maintenance and retail costs and margin (CNG): Includes cost of compression (1 kWh/GGE @ \$0.10/kWh), natural gas utility access fee of \$0.87/MMBTU, and other operating and maintenance costs.

Distribution and retail costs and margin (gasoline): Based on historical spread between retail and wholesale gasoline.

Capital investment (CNG): Based on 1,000,000 GGE/yr dispensed, serving approximately 2000 LDVs or 400 HDVs (avg US gasoline station dispenses 1.1 M gal/yr). Based on \$2.5M capital investment (compressor, dispenser, land) and assumption of 10% cost of capital and 20 year lifetime amortization.

Refining (gasoline): Based on historical spread between crude costs and wholesale gasoline and correlation to crude cost.

Cost estimates and data from NPC 2013 in consultation with Clean Energy Fuels, Chevron, and Exxon Mobil, ANGA 2009 from TIAX in consultation with ANGI Energy Systems, and EIA statistics.

Estimates consistent with American Clean Skies Foundation / Navigant Research cost estimates for infrastructure and retail CNG.

CNG prices: US Department of Energy Clean Cities Program Alternative Fuel Price Report, 2001-2014 (DOE, 2014).

The estimated costs match with historical CNG against natural gas prices, adjusted for taxes⁶. One major takeaway is that feedstock at \$5/MMBTU only accounts for approximately 30% of the CNG price. This can be compared to the 75% of the gasoline price. One conclusion is that natural gas fuel prices have been much less volatile for the consumer and that the cost advantage of natural gas fuel appears to be robust to the commodity price. It can be seen that CNG historically and theoretically provides a consistent fuel price spread of \$1.00 - \$1.50 per GGE (Gasoline Gallon Equivalent). To illustrate the significance of this price spread, fuel savings can amount to \$500-750/yr for a 12,000 mi/yr, 24 mpg light duty vehicle owner, for example, or \$17,000-25,000/yr for a 40,000 mi/yr, 3 mpg transit bus operator.

2.5.3 LNG Cost Analysis

LNG at scale also offers the potential for significant and consistent cost savings for fuel users and the opportunity to profit for fuel suppliers. Using extracted information from the National Petroleum Council report (2013) and TIAX reports based on recent construction cost estimates in the US and interviews, the cost of LNG can be estimated and compared to diesel prices and LNG prices in the US, shown in Figure 11. Costs and prices are in units of USD\$/DGE (Diesel Gallon Equivalent). Like CNG, the total cost of LNG is expected to be more robust to commodity costs than the cost of diesel due to the high proportion of cost to fixed capital and operating costs per gallon, as shown in Figure 11.

⁶ A federal excise tax credit of 50 cents has been available for fuel retailers since October 1, 2006, renewed in 2009 and 2013, for up to December 31, 2013. As well, states have taxed CNG at a discounted rate compared to gasoline. This puts the actual price of CNG slightly higher than the cost estimates, which assume a mature market with high utilization of capital equipment.

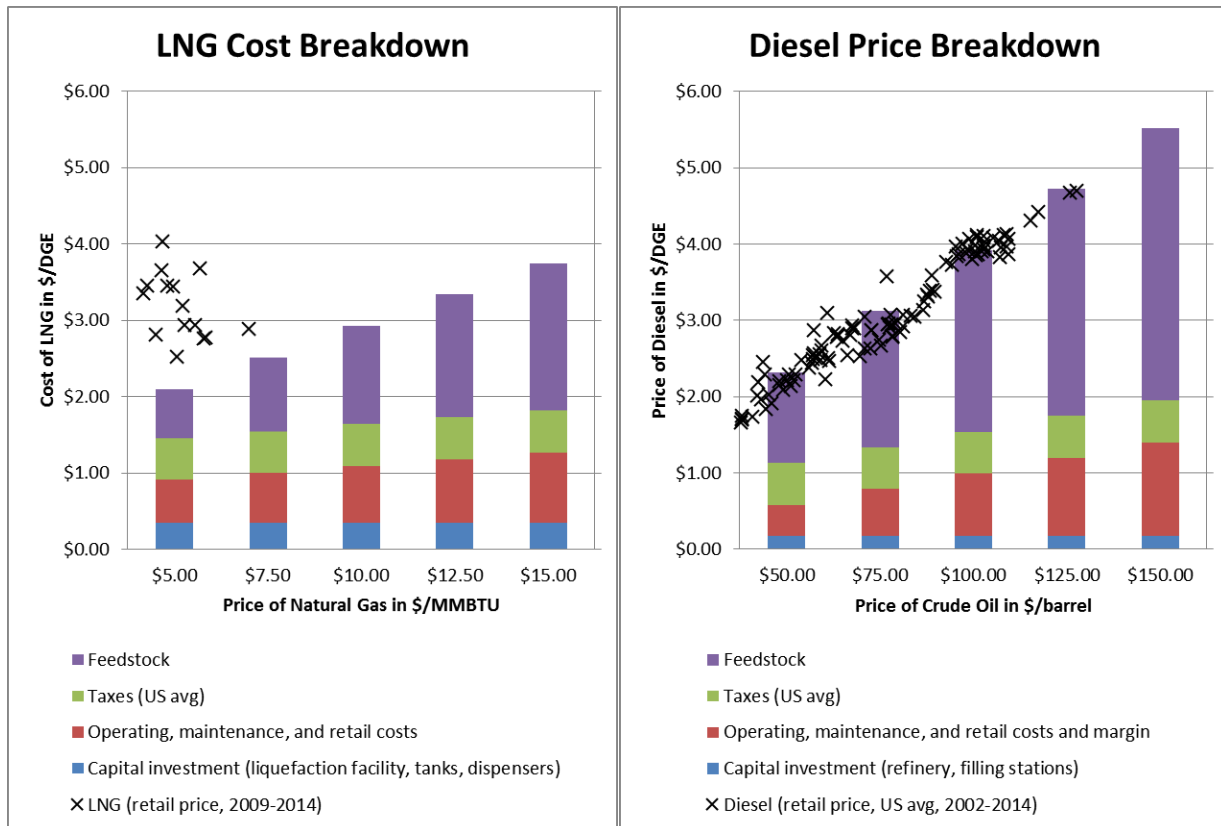

Figure 11: LNG cost breakdown, assuming production at scale

Box 2: Assumptions for LNG Cost

Feedstock: Calculation basis of 0.127 MMBTU/DGE (Diesel Gallon Equivalent) 42 gallons/barrel of oil.

Taxes: Assumption of equivalent per-energy-content taxation of LNG and of diesel; LNG is currently disadvantaged by \$0.13/DGE due to volumetric taxation instead of energy-equivalent taxation.

Operating & maintenance and retail costs (LNG): Includes cost of liquefaction assuming 10% natural gas consumption at LNG plant, electricity consumption, natural gas utility access fee of \$0.35/MMBTU, and other operating and maintenance costs.

Operating costs and margin (diesel): Based on historical spread between retail and wholesale gasoline, and includes refining costs such as energy consumption.

Capital investment (LNG): Based on \$70M liquefaction plant producing 29M DGE/yr at 80% capacity utilization. Equivalent to approximately 0.1 MTPA at \$827/tonne capex. This production rate would supply approximately 8 LNG fuelling stations. Assumption of 10% cost of capital and 20 year lifetime amortization. Station assumed to cost \$2.1M and dispense 3.4M DGE/yr. Each station would serve approximately the fuel needs of 150 Class 8b trucks. Based on Clean Energy Fuels LNG plant in Boron, California, built in 2007.

Capital investment (diesel): Based on historical spread between crude costs and wholesale gasoline and correlation to crude cost, with energy-correlated portion allocated to operating costs and margin.

Cost estimates and data from NPC 2013 in consultation with Clean Energy Fuels.

LNG prices: US Department of Energy Clean Cities Program Alternative Fuel Price Report, 2009-2014 (DOE, 2014). LNG prices extracted from footnotes in individual reports – data unofficially reported due to low number of LNG stations.

While there is a price spread between the expected LNG costs and diesel prices (approximately \$2.00 between \$2.00 (LNG at \$5/MMBTU) and \$4.00 (diesel at \$100/barrel) shown in Figure 11), the limited data on actual prices show that LNG providers have not sold LNG at a discount. One major factor would be the utilization of the capital equipment and the extra cost required to recover fixed capital costs at low sales volumes. Another factor is that LNG liquefaction plants and stations are currently very sparse, which would necessitate much higher transportation costs of LNG fuel. LNG is taxed higher than the energy-equivalent rate by \$0.13/DGE due to volumetric taxation. Finally, LNG suppliers could be pricing their fuel at some linked discount to diesel and earning some margin and return of capital. A recent MIT symposium on alternative fuels was unable to come to consensus on how the savings from cheaper alternative fuels would be split between suppliers and users (MITEI, 2012). It remains to be seen whether LNG prices will behave similarly to CNG prices, which have stayed stable in the \$1.50 - \$2.00/GGE range independent of the natural gas commodity price.

Nevertheless, at a hypothetical price spread of \$0.50-\$1.00/DGE (reduced from the expected \$2.00/DGE), a heavy duty truck operator with 120,000 mi/yr at 6 mpg would be able to save \$10,000-20,000/year.

2.6 Fuel Savings and Payback

Payback is a simple⁷ and commonly used metric for decision makers to understand when the cost of an investment will be recovered via savings. The simple undiscounted payback metric takes the capital cost and divides it by expected annual savings. Fuel savings will depend on miles travelled, relative fuel efficiency, and the fuel price differential. For example, commercial fleet vehicles and heavy duty vehicles can often benefit from a quick payback due to their high mileage and

⁷ Payback can be misleading for long-lived capital investments (e.g. a project with a 5 year payback may be highly profitable if savings are collected for 50 years), but for vehicles, it is an adequate measure, given that passenger vehicles have average lifetimes of 10-15 years, and heavy duty vehicles last 5-10 years and are often sold and re-purposed before their end of life.

fuel consumption. Table 3 provides a rough idea of the payback periods for the different types of vehicles, with the main assumptions listed below. According to the estimated figures in Table 3, private passenger cars have a payback of 5-10 years, light and medium duty trucks, taxis, and vans have a payback of 2-4 years, while heavy duty buses and trucks have a payback of 1-3 years.

Table 3: Estimated payback periods for different vehicle types

Vehicle Type	Additional Cost (%)	Mileage (mi/yr)	Fuel Economy (mpg)	Payback (yrs)
Private passenger cars (Class 1)	10-40	12k	24	5-10
Fleet vehicles e.g. light/medium trucks, taxis, vans (Class 1-5)	10-40	30k	16	2-4
Buses, trucks (Class 6-8a)	10-20	40k	3	1-3
Tractor-trailer combination trucks (Class 8b)	20-40	60-120k	6	1-2

Box 3: Assumptions for Payback

Additional Cost (%): Estimates vary by region and vehicle model –vehicle conversions and lower fuel efficiency (e.g. bi-fuel CNGV, SI LNG) are associated with lower premium.

Mileage and Fuel Economy: Based on US averages for the associated vehicle class.

Fuel Price Differential: Based on range of natural gas prices (\$5-\$15/MMBTU) and crude oil prices (\$75-\$125/barrel) and on assumptions of scale production of CNG and LNG from previous section, resulting in range of payback numbers. Range of prices roughly reflect regional differences in energy commodity pricing.

Final calculations compared with aggregated estimates from Krupnick, 2010; Macquarie, 2012; Lux Research, 2013; Standard Chartered, 2012; National Petroleum Council, 2013.

2.7 Externalities

In addition to their private costs, benefits, and payback, natural gas vehicles are associated with externalities, such as environmental and energy security costs and benefits to society at large. The use of natural gas in vehicles could benefit the environment in terms of local air quality and climate change and could reduce a nation’s petroleum dependence.

2.7.1 Climate Externality

Greenhouse gas (GHG) emissions are the source of anthropogenic global warming and carbon dioxide (CO₂) is the dominant anthropogenic long-lived GHG that will have major impacts on the climate. On an energy basis, natural gas has a lower carbon content and will release 28% less CO₂ than diesel when burned. However, a reduction in engine efficiency of 10-15% for spark-ignited natural gas engines (compared to diesel compression-ignition engines) partially negates this CO₂ benefit. Additional GHG impact may come from unburned methane (CH₄) and from potential leakage in the well-to-wheels life cycle (fuel tanks, fuelling stations, compressors, pipelines, and upstream operations). The potency of methane as a greenhouse gas also raises questions about the climate impact of natural gas use. Estimates of GHG mitigation vary also by the standard used for comparison⁸. A National Research Council (2014) review concluded that NGVs generally emit about 5 to 20 percent less CO₂ at the tailpipe, dependent on drive cycle, vehicle type, and fuel type, and that one specific estimate showed a 13% CO₂ reduction whittled to a 5% CO₂-equivalent reduction when the impact of methane was included (NRC, 2014) (Westport, 2013). The DOE Argonne National Laboratory GREET model puts the GHG reduction figure at 13% for a range of light duty and heavy duty vehicles for the year 2012 (NRC, 2014). The NRC concludes that the inherent tailpipe CO₂ advantage of switching from petroleum to natural gas is “largely (but not completely) offset” by methane and life cycle considerations (NRC, 2014).

2.7.2 Air Quality Externality

Similarly, natural gas generally burns more cleanly than gasoline and diesel and this can lead to reduced tailpipe emissions of particulate matter (PM), sulphur oxides (SO_x), nitrous oxides (NO_x), carbon monoxide (CO), and volatile organic compounds (VOC). These air pollutants are major health and environmental hazards that cause respiratory illnesses, smog, and acid rain. Light duty NGVs

⁸ A comparison of natural gas vehicle emissions to the emissions from a(n old) vehicle on the road, for example, would be biased because it ignores the counterfactual choice of replacing the old vehicle with a new conventional vehicle that faces stringent emissions regulations, even though this may reflect the actual real world reduction in emissions in this replacement scenario.

compared to conventional gasoline vehicles have shown to reduce 60-90% of smog-producing pollutants (TIAX, 2012). However, increasingly stringent EPA and CARB emissions standards in the United States have successfully elicited efficiency improvements and pollution after-treatment and controls for conventional engines and vehicles, blunting the advantage of natural gas combustion (Werpy, 2010). Historically, air quality has been a driver for transit buses and school buses operating in urban environments to convert to natural gas, but new technologies and policy measures have closed the gap in most emission categories when comparing between new vehicles that have to meet the same emissions standards (Werpy, 2010) (TIAX, 2012). Chinese vehicle emission standards have historically lagged European standards by approximately 8 years (ICCT, 2014), and NGVs in China may still environmentally outperform other vehicle choices in the short run.

2.7.3 Energy Security Externality

95% of transportation energy use comes from oil in the United States (EIA, 2013) and oil imports now supply 45% of total consumption in the US (EIA, 2013), 80% of EU consumption, and 50% of China's consumption (IEA, 2012). These are some of the statistics that lead to discussion about the military and macroeconomic costs of petroleum consumption and imports. However, these costs are understandably difficult to attribute or estimate. Qualitatively, in regions of the world with abundant natural gas such as the US, natural gas is heralded as an economical alternative fuel from domestic sources. In China and the EU, natural gas is also promoted as an alternative fuel that can help diversify imports and mitigate petroleum dependence (NDRC, 2013) (IGU, 2012).

2.8 Policies and Trends

Governments around the world have supported alternative fuels with many policies to help mitigate the many externalities of petroleum consumption. All three components – fuel, vehicles, and infrastructure – are commonly subsidized via tax credits, incentives, or direct price controls. Air quality regulations, alternative fuel mandates, vehicle emissions and fuel economy standards are other policies that incentivize or motivate natural gas vehicle adoption. Governments and public

entities including regulated utility companies and state-owned enterprises can invest in infrastructure directly and procure natural gas vehicles for their own fleets.

In the United States, President Obama has been supportive of the production and consumption of “clean and American” natural gas. Energy policies in the past have included infrastructure tax credits for CNG fuelling stations. California’s Low-Carbon Fuel Standard and the recent updates to fuel economy standards provide special consideration to natural gas as a vehicle fuel. Private initiatives such as the Pickens Plan and fleet purchases by UPS and Waste Management have benefited from government incentives.

Driven by concerns of energy security and urban air quality, Beijing has made concerted efforts to increase the use of natural gas economy-wide and especially in transportation. Under the 2012 update to the National Development and Reform Commission (NDRC) Natural Gas Utilization Policy, natural gas vehicles (with special emphasis on LNG vehicles) have been deemed a priority user of natural gas over some electric power generation uses and chemical industry use (NDRC, 2013). A domestic industry has been developed to supply natural gas vehicle equipment and infrastructure. Chinese state-owned enterprises have led the charge in expanding both CNG and LNG infrastructure, again with special emphasis on LNG production and distribution.

Climate policy is a big-picture issue that will affect the future of energy systems and technology deployment. Although the GHG emissions reduction potential of natural gas transportation itself is limited (in the order of 5-20%), there may be significant general equilibrium effects of increased demand for natural gas in other sectors such as electric power and between different regions. For example, Venkatesh et al (2011) argue that natural gas used for transportation carries a high risk of policy failure if meant to reduce GHG emissions and that limited supplies of natural gas should be assigned to displace coal. The temporal aspect of climate issues is also of concern – natural gas might make sense in the short term but not in the long run when a shift to much-lower-carbon energy is needed for climate stabilization.

Another important trend that would affect natural gas vehicle adoption is the development of alternative and competing vehicle and fuel technologies. In the light duty segment, hybrid vehicles and flex-fuel vehicles are alternative vehicle technologies that also lead to fuel cost savings. Over the longer term, developments in electric vehicle technology and fuel cell technology may compete strongly against natural gas vehicles. In the heavy duty segment, electric vehicles are not considered a strong competitor, but other fuel efficiency technologies including hydraulic, kinetic, and electric hybridization or the use of biodiesel may be preferred to switching to natural gas.

2.9 Implications for Modelling

Natural gas vehicles have the potential to make large contributions in existing energy systems via the displacement of petroleum with natural gas. However, the prospects and impacts are affected by many system-wide factors and feedbacks that will play a role in determining the prospects and impacts of natural gas as an alternative transportation fuel. The engine and vehicle technologies are based on mature combustion technology and already participate in all segments. While natural gas fuel can be offered at substantial discounts to gasoline and diesel, allowing it to compete as an alternative fuel in many regions of the world, the investments needed for CNG and LNG infrastructure and the “chicken and egg” problem are key barriers to widespread adoption. Sales volume and high utilization of capital investment is necessary to defray the per-unit costs, but this is difficult to guarantee without the vehicles; meanwhile, consumers and fleet managers want to see available fuel supply before making the investment in alternative fuel vehicles.

There have been pockets of significant light duty natural gas vehicle adoption in countries such as Iran, Pakistan, Argentina, and China, but the predominant type of vehicle is the bi-fuel CNG vehicles with a small tank to supplement regular gasoline use. These vehicles are often serving specific segments such as taxis, passenger vans, and mini-buses. The low overall vehicle penetration in these countries also inflates the penetration percentage figure. Other explanatory factors include the presence of natural gas “gluts,” the lack of infrastructure for export, and strong policy backing. Other factors that work against light duty market penetration

include the reduced range and cargo space of light duty CNG passenger vehicles, the unfavourable payback for personal use, the investments needed for a large network of CNG fuelling stations, each with compressor equipment, and the emerging availability of other fuel-saving technology such as hybridization and flex-fuel capability and alternative competing technologies such as plug-in electric and hydrogen fuel cell. Given that the externality drivers may not be as strong as they once were, there may not be as much appetite for further policy push into CNG vehicles except where regional-specific factors dominate.

The heavy duty segment, in contrast, is poised to take advantage of much more significant cost savings, as represented by the much shorter payback periods. The commercial nature of heavy duty fleet vehicles may encourage business-minded decisions to pursue these fuel cost savings. The infrastructure requirements and costs for LNG are lower (on a per unit basis) when at scale and the state-led roll-out of LNG infrastructure in China has happened at a staggering rate. The lack of other alternatives in the heavy duty vehicle segment also plays a role in the favourable prospects of natural gas buses and trucks.

In the next section, I describe how the main characteristics of natural gas vehicles can be introduced into a global energy-economic model. As with any modelling, many details have to be simplified, but this approach allows the simulation and testing of the major trends and drivers of adoption.

3 Modelling Heavy Duty LNG Vehicles in Computable General Equilibrium (CGE)

3.1 General Equilibrium Modelling

Adoption of a new technology such as natural gas vehicles in the global energy system can create many effects in the economy, in energy use patterns, and to the environment and climate. Though natural gas vehicles do not have the potential to mitigate climate change as significantly as other technologies such as renewable power or electric vehicles, their imminent economic viability and their potential to displace the dominant fuel in transportation represent a significant fuel switching pathway in the energy-economic system.

With this type of shift, it may not be clear what the overall impacts on the natural gas market and related markets of oil, coal, and associated GHG will be. How might natural gas vehicle (NGV) adoption impact energy prices, energy flows, energy trade, and global greenhouse gas emissions? Furthermore, how would these impacted factors affect NGV adoption itself? These factors could constrain or drive adoption in return. Then, how might natural gas vehicle adoption respond to trends and policies and then also affect and impact the policy targets themselves? For example, natural gas has many competing and growing demands and applications that also promise improved energy security and emissions reduction. In the electric power sector, natural gas increasingly serves as an economical substitute to coal when burned in combined cycle power plants and could also serve as a valuable complement to intermittent renewable power sources. Venkatesh et al (2011) argue that natural gas used for transportation carries a high risk of policy failure if meant to reduce GHG emissions and that limited supplies of natural gas should be assigned to displace coal. So, while the displacement of oil with natural gas vehicles has its benefits in fuel cost reduction, energy security, and emissions reduction, an alternative world exists in which that natural gas may have generated greater economic and environmental benefits by displacing coal in the electric power sector.

How might resources be best managed in the public interest? The mainstream approach is the utilitarian economic approach, which would use prices to mediate

between the many competing demands for resources. A class of economic models, computable general equilibrium (CGE) models, serve the purpose of simulating economic agents making choices consistent with observed and theoretical market behaviour. These models optimize for market equilibrium prices and quantities by maximizing household utilities and minimizing costs to firms (or put another way, the maximization of profits to firms) within the constraints of budgets and resource endowments.

General equilibrium economic modelling can help investigate the prospects and impacts of a new alternative fuel technology and the associated interaction and system effects. For example, natural gas use in vehicles might increase the price of natural gas and this price effect may discourage its use in other sectors or regions. General equilibrium modelling is also meant to help inform decision making in arenas such as energy and fuel policy, technology policy, and climate policy. Scenarios and options can be evaluated and compared via changes in parameters, variables, and scenarios, helping the modeller understand differences between uncertain future states of the world and also between different policy options. Natural gas is expected to play a major role in displacing conventional energy in a carbon-constrained world in the short term, yet it too needs to be pushed out of the energy mix in the long run in scenarios with successful climate stabilization. How do the prospects of natural gas for transportation fit in this larger picture? What role and impact would NGVs have in this picture if natural gas is to be a bridge to a low-carbon future?

3.2 The MIT Emissions Prediction and Policy Analysis (EPPA) Model

The MIT Emissions Prediction and Policy Analysis (EPPA) model is a multi-sector, multi-region CGE representation of the world economy developed by the MIT Joint Program on the Science and Policy of Global Change (Paltsev et al, 2005). The EPPA model solves for equilibrium prices and quantities in a simulation of economic behaviour, represented by minimization of cost and maximization of welfare. Production and consumption sectors are represented by nested Constant Elasticity of Substitution (CES) cost functions that allow for price-driven substitution of inputs and input bundles. EPPA uses a database of input-output economic flows from the

Global Trade Analysis Project (GTAP) (Narayanan et al, 2012) for the specification of the base year economy and is written in GAMS and the MPSGE modelling language. Figure 12 shows a high-level schematic of EPPA, in which consumers endow producers with primary factors such as capital, labour, land, and energy resources in exchange for income, and producers create goods and services that are purchased by consumers via expenditures and are tradeable between regions.

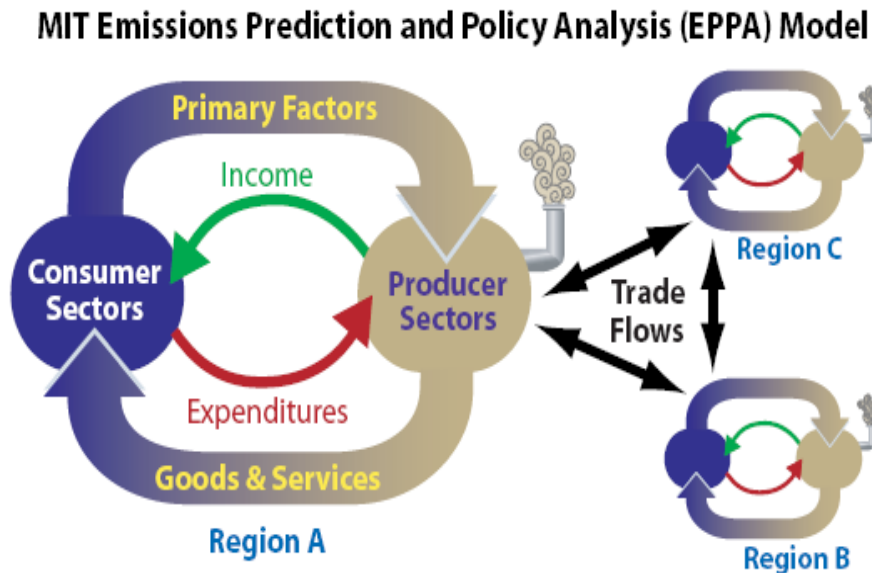

Figure 12: MIT Emissions Prediction and Policy Analysis model

Source: Paltsev et al, 2005

The nested structure of the typical producer and consumer sectors in EPPA are shown in Figures 13 and 14. The nests show the flexibility of producers and consumers to use different inputs depending on price and elasticity of substitution. For additional information on the EPPA model, see Paltsev et al, 2005.

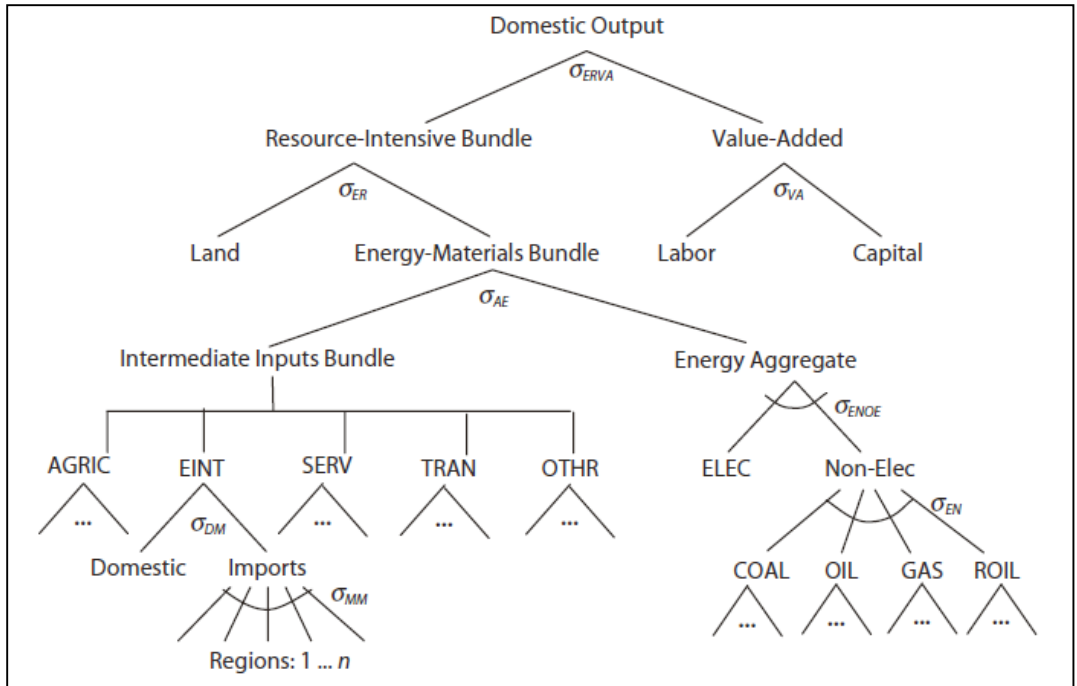

Figure 13: Nested structure of producer sectors in EPPA

Source: Paltsev et al, 2005

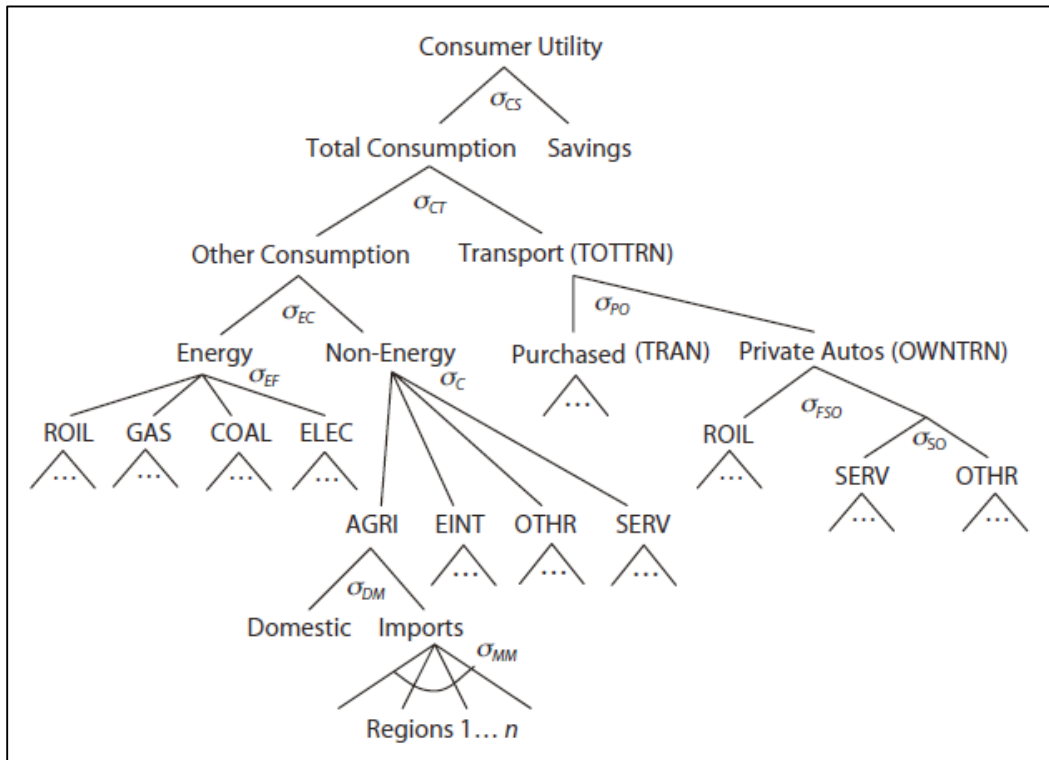

Figure 14: Nested structure of consumer sectors in EPPA

Source: Paltsev et al, 2005

EPPA was originally built to evaluate energy and climate policy. As such, there is a focus on explicit and detailed representation of energy and environment related sectors such as agriculture, transportation, and electric power. Emissions such as greenhouse gases and air pollutants are tracked and reported. Factors such as different types of land for biofuels and various fossil fuel resources are represented in detail. In terms of technology, the electric power sector includes options for natural gas combined cycle (NGCC) power plants, traditional and advanced nuclear power plants, coal and natural gas power plants with carbon capture and sequestration (CCS), biofuels, wind, and solar. These different types of power sources have their own specifications derived from bottom-up engineering analysis. For transportation, household passenger vehicles have been disaggregated from household consumption of manufactured products and refined oil to explicitly represent private vehicles (Paltsev et al, 2004). This was used for the modelling and simulation of transportation policies such as fuel economy standards (Paltsev et al, 2005) (Karplus, 2011) (Karplus et al, 2013).

Alternative fuel options have also been modelled in EPPA for the household passenger vehicle fleet, including biofuels (Gitiaux et al, 2012), plug-in electric vehicles (Karplus et al, 2010), hydrogen fuel cell vehicles (Sandoval et al, 2009), and CNG passenger vehicles (Kragha, 2010). Furthermore, Karplus et al (2013) made several advances in VMT demand estimation and in modelling structure to capture opportunities in fuel efficiency. Other work on the transportation sector include disaggregation of aviation for specific study (Gillespie, 2011) and disaggregation of freight, commercial, and on-road/off-road transportation modes in China (Kishimoto et al, 2014).

3.3 Modelling New Transportation Technologies in EPPA

Technological change is represented in the EPPA model in several ways. First, most production inputs can undergo price-driven substitution of factor inputs such as capital, labour, and energy. For example, depending on relative price, EPPA may equilibrate at a point where an economic agent spends more on capital investment such as insulation, advanced lighting, or a hybrid electric vehicle, in order to save on energy costs and minimize total expenditure, or vice versa if energy prices are

relatively low. Another representation of technological change in EPPA is the exogenous specification of the Autonomous Energy Efficiency Improvement (AEEI) parameter. This factor reduces the energy input required for production over time, simulating general advances in technology that are not predicated on energy prices. Examples include lighter materials or process improvements.

While these two mechanisms are able to simulate incremental changes within sectors, advanced technologies that represent major shifts in factor inputs and impacts require explicit specification and representation of new pathways. These technologies are known as “backstop” technologies that endogenously enter the economy when they become economically competitive with existing technologies under conditions such as high conventional energy prices or climate policy (Nordhaus, 1973). For example, a switch to power plants with CCS would entail new inputs and outputs that would be represented as a technology backstop. In the case of substituting diesel fuel for liquefied natural gas as an alternative transportation fuel, a backstop technology will need to be implemented in EPPA.

The first step of creating a backstop technology sector is to determine where it will fit within the existing CGE model. Then, inputs and outputs would need to be assigned. A nesting structure would be specified to organize how inputs might substitute for each another. Finally, several parameters would need to be specified and calibrated, including the breakdown of input costs, elasticities of substitution, technology cost adjustment known as “mark-up” (Paltsev et al, 2005), and a technology specific factor that governs technology penetration. It is expected that results will be sensitive to parameter specification. This work will investigate the process of backstop specification and calibration.

3.4 Disaggregation and Segmentation

The first step is to identify where a new backstop technology would fit in the economic structure of the model. The decision to model LNG for heavy duty vehicles means that the output would fall into the aggregated TRAN sector. TRAN is one of EPPA’s industrial sectors that supplies transportation services to other sectors of the economy and to households. It excludes household-owned

transportation, but includes air, water, and road commercial transport. The input structure is shown in Figure 15. This nesting structure is generic between other industrial sectors. Intermediate inputs and the KLE (capital, labour, energy) bundle are combined to produce transportation output.

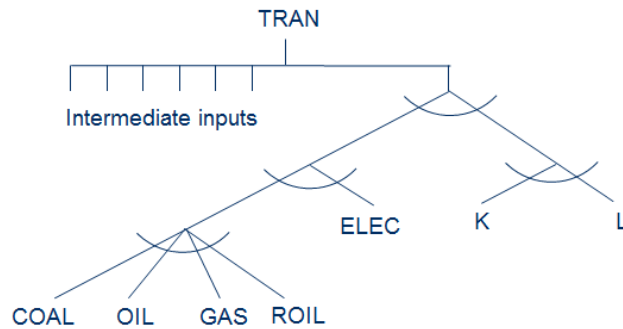

Figure 15: Existing transportation sector in EPPA

In the base year, the data for this TRAN sector is an aggregate of the ATP (air transport), WTP (water transport), and OTP (other transport) sectors in the GTAP database that serves as a benchmark for the EPPA model. Because TRAN includes all of these non-household transportation services, such as the activity of airlines, shipping companies, buses, trains, and trucks, the first model modification needed is the disaggregation of the existing transportation sector into two segments: one in which LNG-fuelled transportation will compete in, and another where LNG will not compete in. Importantly, this serves as an estimate for an upper limit for which LNG can substitute into the transportation sector.

The level of aggregation in the top-down CGE approach precludes a narrow specification of Class 8b trucks. One of the modelling approximations needed is the share of outputs and inputs that should be disaggregated from the TRAN sector. An analysis of the base year (2007) input-output data for the United States from GTAP shows that out of the \$5.48 trillion USD of TRAN output, \$4.03 trillion is from OTP (all other transportation services excluding air and water). While LNG shows some promise in the marine transportation sector, it is not in the scope of this work. The remainder is a mix of freight transport on trucks, trains, pipeline, and off-road vehicles, and passenger transport on buses, trains, taxis, transit, and rental vehicles. OTP can also be disaggregated into end use, which allows the separation

of output by where it is consumed. By excluding household expenditures on transportation services, an approximation of freight transport is achieved, although business travel (by land) is inevitably included. This leaves \$2.60 trillion of transportation services that is consumed as an intermediate input by other sectors. Two further approximations are applied, including the accounting of vehicle class (Class 8b activity representing approximately 2/3 of trucking activity) (NPC, 2013) and the approximate exclusion of rail and pipeline and business travel. This leaves an estimated 20% of the TRAN sector to represent the heavy duty vehicle segment that can switch to using LNG. The model does not consider potential changes in truck types and use or transportation modal shifts, e.g. more goods shipped by larger trucks or by intermodal rail in the future.

With this disaggregation in place, the backstop technology of LNG trucks can then enter as a perfect substitute⁹ to the isolated segment of 20% of TRAN. This is shown in Figure 16. The details of the inputs are provided in the next section.

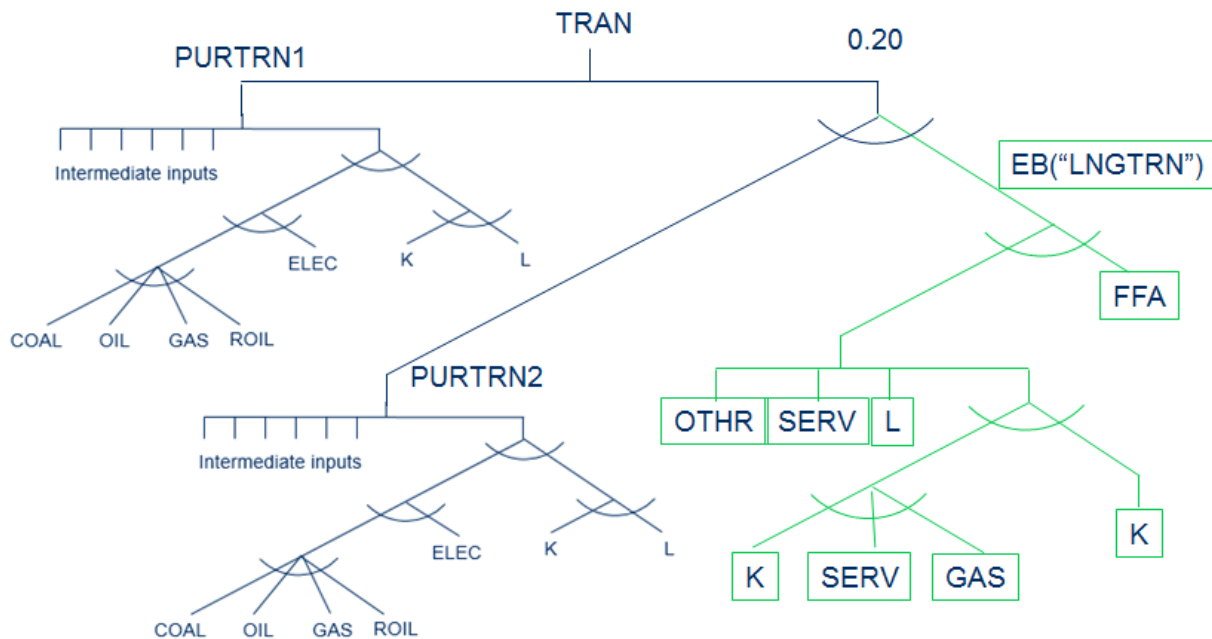

Figure 16: Disaggregated transportation sector in EPPA with backstop technology sector representing LNG trucks

⁹ The modelling choice of perfect substitutability and output equivalence reflects the approximate homogeneity of vehicle performance characteristics between Class 8b trucks fuelled by diesel and LNG (operation, range, fuelling time, fuel supply and distribution). The difference in fuel economy is accounted in the input share calculations below.

3.5 Cost Structure

The next major modelling task of representing an advanced backstop technology in the EPPA model is the construction of the cost structure of the production sector. Because the backstop technology is being modelled as a perfect substitute to the 20% segment of the TRAN sector, the input structure of the backstop should approximately correspond to the original TRAN sector¹⁰. To start, Class 8b trucks represent a mode of transport that is more fuel and labour intensive than the aggregate TRAN sector, as shown in Figure 17, where driver payments (35%) is larger than the 27% for LABD (labour expenditures) in the TRAN sector aggregate and the fuel costs (40%) is larger than the ROIL (refined oil) expenditures (29%).

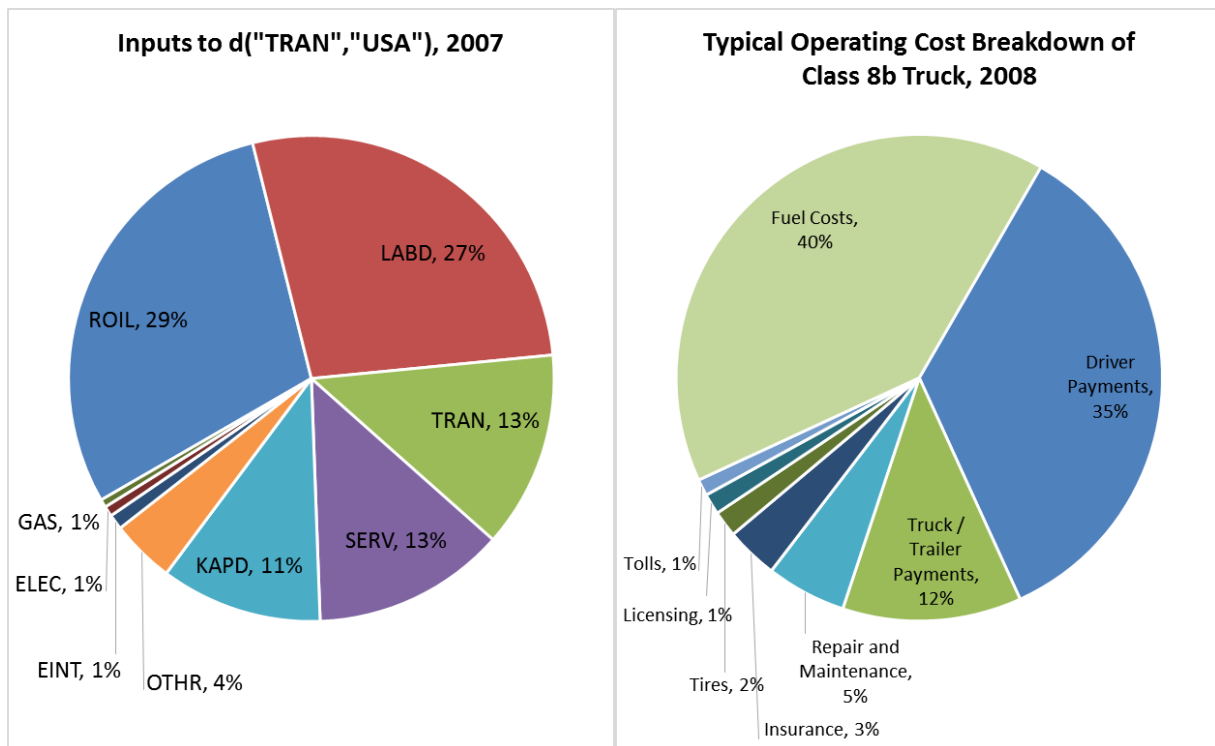

Figure 17: Inputs to the transportation sector in EPPA and corresponding inputs to Class 8b trucking

Sources: GTAP 2007 from Narayanan et al, 2012; ATRI, 2008

¹⁰ The aggregation of many modes, types, and classes of transportation in TRAN means that the output and the inputs must remain representative of a high-level average across modes, types, and classes.

Because there was not enough data to disaggregate the 20% segment of TRAN specifically into a segment of only Class 8b trucks, a modelling choice was made to keep the structure and inputs consistent with the TRAN sector, so that the backstop technology would not be biased towards producing Class 8b truck services rather than average TRAN sector output.

For the LNG truck option, all inputs were preserved at their share except for the fuel cost. Using 2007 prices (2007 being the base year for the data), the energy-equivalent amount of LNG needed was estimated to cost 69% of the equivalent diesel needed, after accounting for a fuel economy penalty of 5%¹¹. In the new backstop production function, this is reflected by the resulting 28% of output needed for fuel input, shown on the left side of Figure 18. This conversion is important in that it maintains the correspondence between the economic quantities (value in dollar terms) and the physical quantities (energy and emissions) that are tracked within the EPPA model.

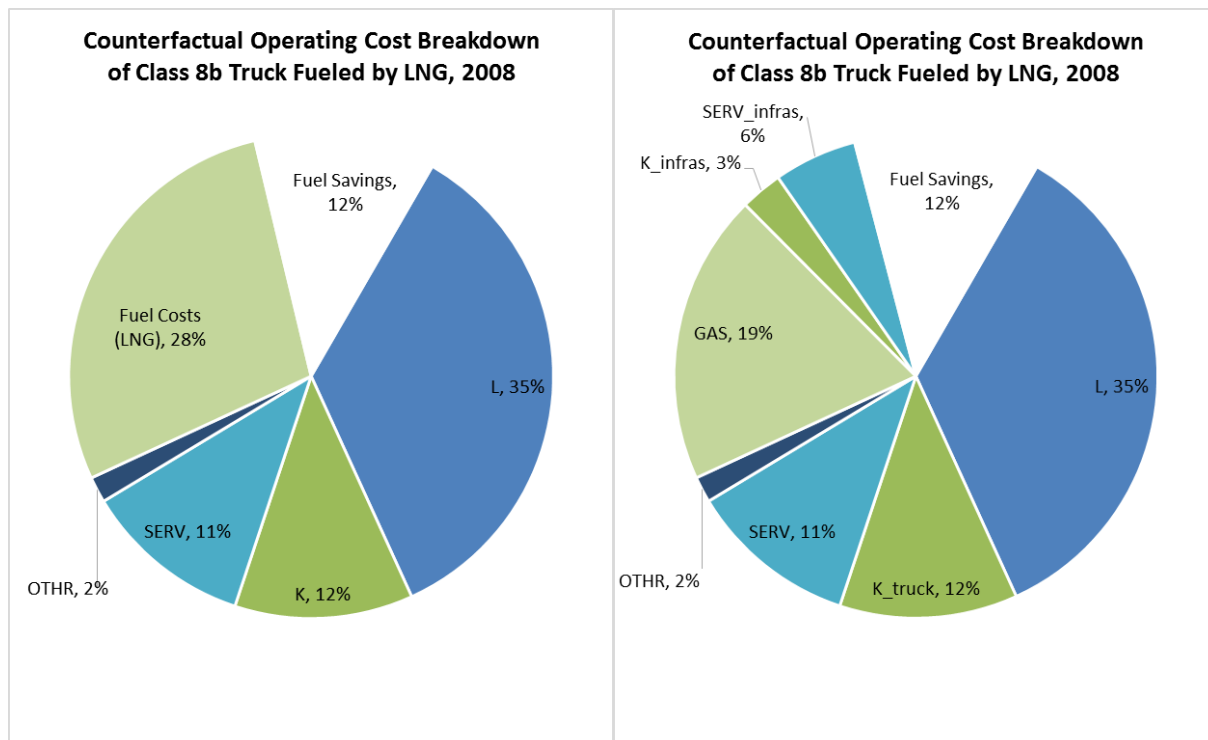

Figure 18: Derivation of the input shares for the LNG truck backstop technology sector

¹¹ 5% reflects long-run assumptions of a 50-50 mix of SI and CI engine options and a 10% penalty for SI NG engines.

One lingering issue is that in competitive economic equilibrium, all prices equate to the marginal cost of production and there would be no economic profits¹² for producers. This forms one of the constraining conditions for a solution to the computable general equilibrium problem. The unresolved question is how to treat the potential for economic gains from the difference between the cost of using conventional diesel fuel and the cost of using LNG for transportation, which represented 30% in savings (12% of the total cost) as of 2007. At one extreme, LNG might be produced and sold at cost by producers who are looking for new markets for natural gas, leaving the trucking industry to assume the savings from the inherently lower value and price of natural gas compared to petroleum on an energy-equivalent basis. In this case, LNG prices would be decoupled from conventional fuel prices. On the other hand, LNG producers and suppliers may recognize this increased value of LNG supplied to vehicle operators and charge a price that is much closer to the equivalent diesel price. A recent MIT symposium on alternative fuels was unable to come to consensus on how the savings from cheaper alternative fuels would be split between suppliers and users (MITEI, 2012).

A review of the difference between the cost and price of LNG in Figure 11 shows that the LNG (as a vehicle fuel) market is not at the long-run economic equilibrium. This difference can be accounted by 1) a higher capital cost recovery needed because of low sales volumes; and/or 2) margins and profits (also a return to capital) from the ability to price LNG close to diesel fuel because they are acting as economic substitutes. Because of the zero-profit condition in computable general equilibrium (CGE), this gap between inputs and outputs would be invalid within the CGE framework in the base year because there would be no contest between the conventional TRAN sector of spending \$1 of input to get \$1 of output and this backstop technology that only requires \$0.88 of inputs to get \$1 of output in the base year. However, the whole picture has not been captured yet because the cost of the truck needs to be adjusted for the premium of an LNG truck. This favourable ratio of input and output values in the base year is a function of the near-term

¹² Accounting profits still exist; economic profits reflect opportunity costs and rate of return.

economic viability of this backstop technology, unlike other alternative energy technologies modelled in EPPA.

Finally, while the other inputs can be classified into corresponding EPPA sector commodities, LNG fuel cost is not directly translated into the GAS commodity in EPPA. Using LNG cost breakdown estimates as previously shown in Figure 11, the fuel cost is split into capital infrastructure costs, operating costs, and commodity cost (which includes a 8% increase in GAS input for liquefaction). This is shown on the right side of Figure 18.

3.6 Mark-up Factor

Advanced technologies, compared to their conventional counterparts, are usually more expensive in terms of input costs, excluding externalities. Most advanced technologies are not considered economical on a cost basis at today's prices, and this can remain true even in the long run after further technological advancement. However, estimates of technology costs are uncertain and can vary significantly over time and experience. In modelling this advanced technology, this parameter of technology cost should be set as a variable. In the EPPA model, the mark-up factor represents the long-run n-th plant cost, relative to the base year cost of the substitutable competing technology. The n-th plant cost is meant to represent the cost of a mature technology that approximately has no further reductions of cost, with "n-th" meaning that the technology has achieved scale and that it is no longer relevant how many units have been produced before this n-th unit. This incorporates assumptions of large-scale production, cost reductions from learning and experience, and high plant and equipment utilization from full-scale deployment. For example, in the electric power sector, the EPPA model uses long-run engineering estimates of the levelized cost of electricity (LCOE) from different types of power plants from the US Department of Energy. The costs of natural gas combined cycle (NGCC) power plants, integrated gasification combined cycle (IGCC) power plants, NGCC and IGCC plants with carbon capture and storage (CCS), advanced next-generation nuclear power plants, wind turbines and farms, and solar panels and parks are built up in a bottom-up analysis, and then compared to the

base year cost of a pulverized coal (PC) power plant, which is the standard technological option as modelled by the EPPA model.

The mark-up factor is a hurdle for a competing technology to supply its sector. While the mark-up factor means that the technology is uneconomical at the base year, the backstop option may become viable when relative prices change as a result of market forces or when externalities are priced under scenarios with policy. For example, if the mark-up factor of a renewable power source was 1.2, representing its LCOE being 20% higher than the LCOE from a pulverized coal (PC) power plant in the base year, then the model would select this renewable power plant if the price of electricity increases to 1.2. This would mean that relative prices of inputs have changed so that the sum of the input costs of the PC plant has increased to 1.2. For example, the price of coal and its associated CO₂ could increase so that the LCOE cost of operating the PC plant is more than 20% higher than the LCOE at base year prices. This would then make the renewable power plant more economical than the conventional power plant and result in the backstop technology being preferred for supplying electricity, until its own input costs such as land resource or capital become just as expensive as the new equilibrium price for electricity supply.

To model an advanced technology in transportation, the representative conventional technology must first be selected and its cost estimated. In this case, the counterfactual diesel truck and diesel infrastructure is used to scale the input costs of the advanced backstop technology, an LNG truck and LNG production and distribution infrastructure.

In preliminary testing, changes in the mark-up factor resulted in expected consistent behaviour. In Figure 19, the adoption of the backstop technology is faster in test scenarios with lower mark-up factors, attributable to higher cost savings and better economic viability.

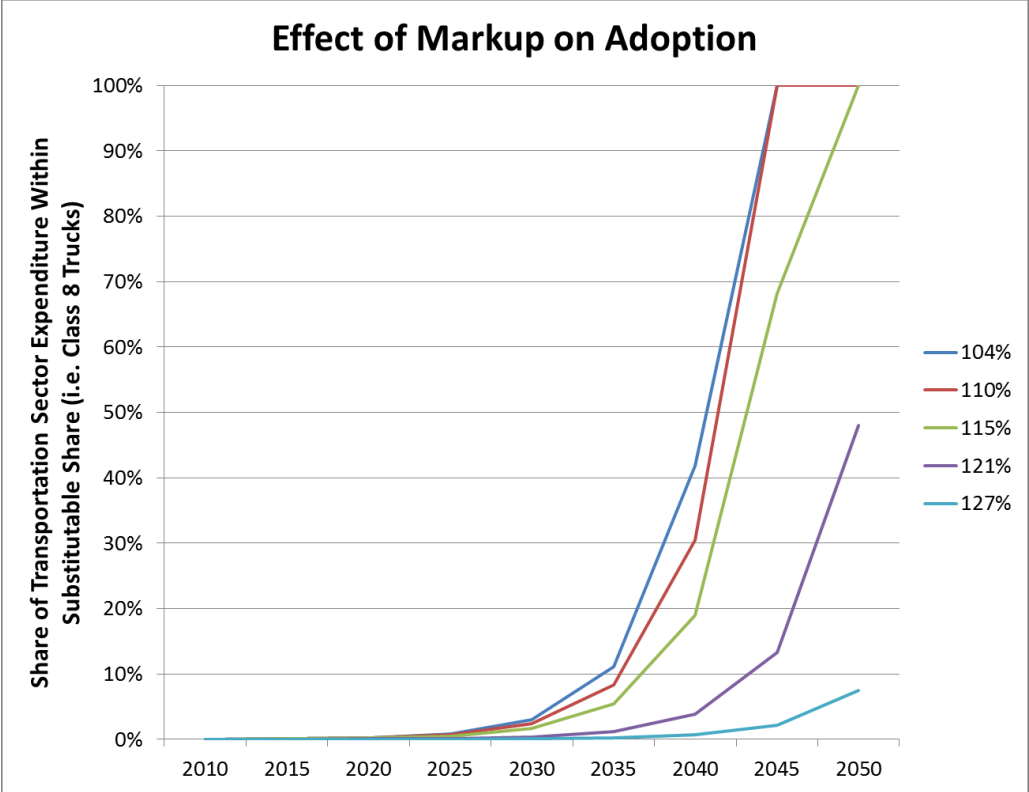

Figure 19: Result of testing mark-up variation on adoption rate of LNG truck backstop technology

3.7 Technology-Specific Factor

In addition to the mark-up parameter that adjusts the technology cost to its long-run cost premium over the existing technology, a technology-specific factor is needed to simulate the adoption dynamics of the backstop technology. Because it is the n-th unit cost that is implemented into the CGE model, the model up to this point would allow advanced technologies to penetrate immediately based on their n-th unit cost. A jump to 100% sales, as illustrated in Figure 20, is unrealistic due to many constraints, and a technology-specific factor input serves to govern the growth of the backstop technology sector, reflecting constraints to technology penetration.

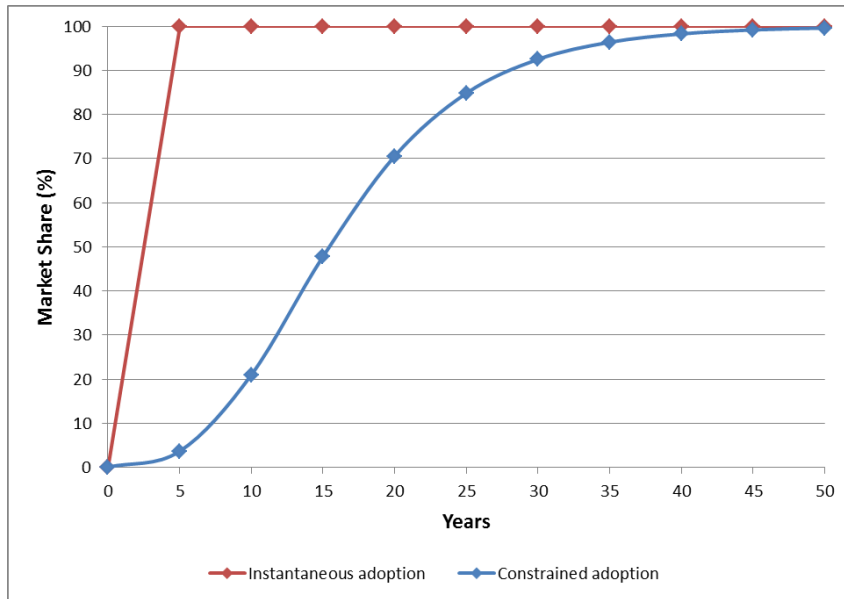

Figure 20: Illustrative examples of technology adoption

The adoption rate constraints include the time, effort, and costs for production to scale up and for manufacturing facilities to re-tool; for engineering knowledge, skills, and expertise to get past initial unfamiliarity; and for regulatory capacity to adapt to new technology regimes. Other constraints include supporting infrastructure and supply chain build-out, capital turnover, and user and customer familiarity and trust. The technology-specific factor represents the costs of overcoming these barriers and constraints, such as the cost of re-tooling, training, and the attention and expertise dedicated to the new technology, in the form of scientists and engineers and R&D to get past deployment hurdles. These costs can be viewed as the difference between the first unit cost and the n-th unit cost. The technology resource factor is needed to represent the high cost of the first few units of the technology before it is mature.

The 1st to n-th cost adjustment over time has been analyzed in the literature (Nagy et al, 2013) and implemented in bottom-up models in various forms. T. P. Wright¹³ (1936) was one of the first to describe the experience curve of a technology (specifically, the cost of aircraft related to past production) and hypothesized that learning-by-doing would cut costs. He found the unit cost of technological products

¹³ No relation to the Wright brothers

to be exponentially related to cumulative production, a proxy for invested effort and accumulated knowledge. Gordon Moore in 1965 formulated his prediction of falling costs differently and simply observed exogenous improvement with time. This can be modelled as performance improvements and cost reductions as an exponential function of time. Goddard (1982) found a third factor in technology cost reduction, which was economies of scale, and modelled cost reductions as a function of the previous annual production as a proxy for production scale or capacity. Sinclair, Klepper, and Cohen (2000) and Nordhaus (2007) use a combination of these factors.

In the EPPA model, the technology-specific factor resource is in limited “fixed” supply at a given point in time, and the resource grows as a function of previous period’s production, representing the build-up and accumulation of expertise and knowledge. The technology-specific factor is modelled as an input to the cost structure of backstop technologies and is in high demand when the economics of all the other inputs make sense. The price of the factor is driven up from this demand and some of the potential technology adopters give up until an equilibrium adoption is reached. With the growth on the factor every period, it eventually becomes non-binding once a critical mass of technology-specific factor is reached. Growth in this factor resource simulates the learning-by-doing and economies of scale phenomena that are not explicitly represented. In this specification of the technology-specific factor, the growth in the factor resource is endogenous in that past production determines how much is added to the next period’s factor supply.

The functional form of the technology-specific factor and its growth in the EPPA model is based on Jacoby et al (2006) and updated by Morris et al (2014). For electricity technologies such as renewable power plants and fossil fuel power plants with carbon capture and storage, the growth of the technology-specific factor is calibrated to the adoption of nuclear power in the United States in 1970-1987. In Karplus et al (2013), the technology-specific factor for plug-in hybrid electric vehicles was calibrated to hybrid vehicle adoption history in the 2000s.

For the LNG truck backstop technology, the adoption rates and histories of other transportation and fuel technologies were studied and compared in Figure 21.

Considering technological maturity and industry structure, the growth in the technology-specific factor for Class 8b LNG trucks was calibrated to the growth Class 8 truck adoption of diesel, which had previously run on gasoline only. This calibration and specification of the technology-specific factor growth does not specify the adoption rate of the technology, but rather constrains the growth by limiting the supply of the technology-specific factor resource, thereby adjusting the economics of the adoption of the technology.

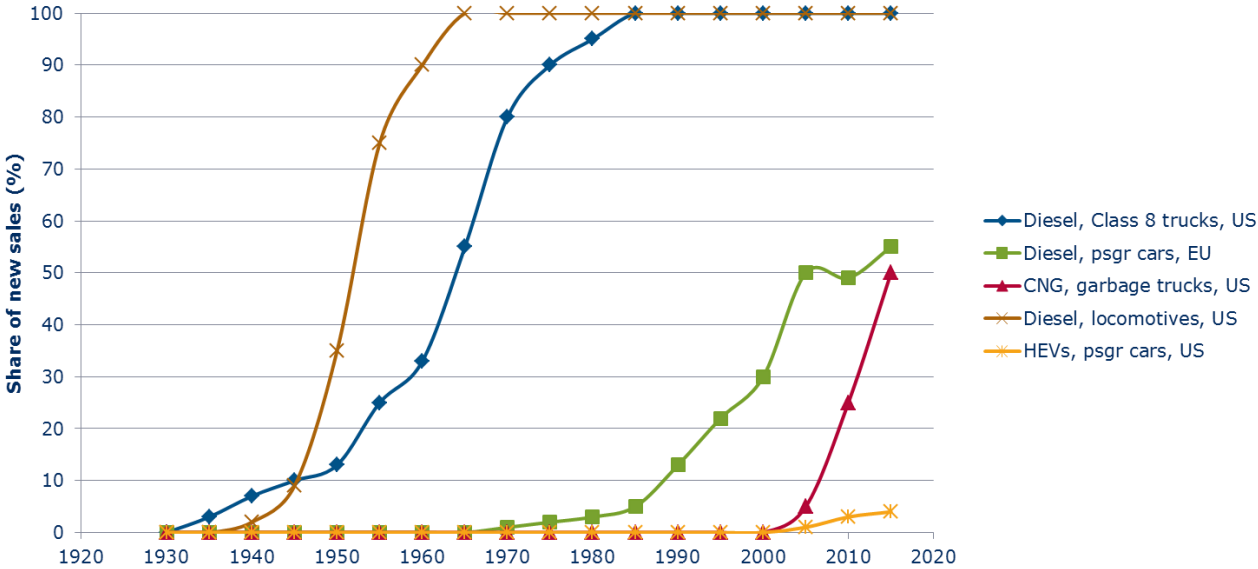

Figure 21: Historical adoption rates of vehicle technologies

Source: Westport, 2013

3.8 Uncertainty in Mark-up Factor

Although best estimates from bottom-up engineering studies are used to set mark-up factors in the model, there are many assumptions that are included that would change the n-th unit cost of the technology. For example, the utilization rate of a power plant or a fuelling station will determine how its capital cost is distributed per unit of electricity or fuel. The utilization factor assumes a certain structure in the sector. In electricity, a baseload power plant may not run as often as expected with increased renewable power penetration in the electricity supply mix. In transportation, a fuelling station may not reach its expected service levels if customers do not adopt the vehicles at the assumed level. The cost of fuel

distribution of LNG may also change depending on the eventual concentration and proximity of LNG infrastructure. To illustrate the impact, an 80% utilization factor estimate revised down to 60% would increase the capital cost per unit of output by 33%. This would have a net effect of 7% on total cost if the capital cost portion was 20% of the total cost. Because cost estimates vary significantly and suffer from uncertainty and endogeneity, a wide range of mark-up factors needs to be tested while keeping the cost structure and accounting of physical energy quantities consistent. In addition, beyond the conventional single mark-up approach in EPPA, specific mark-ups for the vehicle premium and the infrastructure cost uncertainty were disaggregated so that they could be applied and tested separately.

For the vehicle cost component, a range of 120% - 160% was tested, representing a range of cost premiums. The estimated retail premium for a LNG truck today (2010-2015) is about \$60,000 (for a 50-50 mix of SI and CI engine options) and \$75,000 for the CI option (NPC, 2013), represented by the upper bound of the mark-up range (50-60%). For the lower bound, a 20% premium represents the expected cost of a SI engine and tank around 2025 at \$24,000 (NPC, 2013). Retail prices and estimates were sourced from NPC (2013) and are shown in Figure 22.

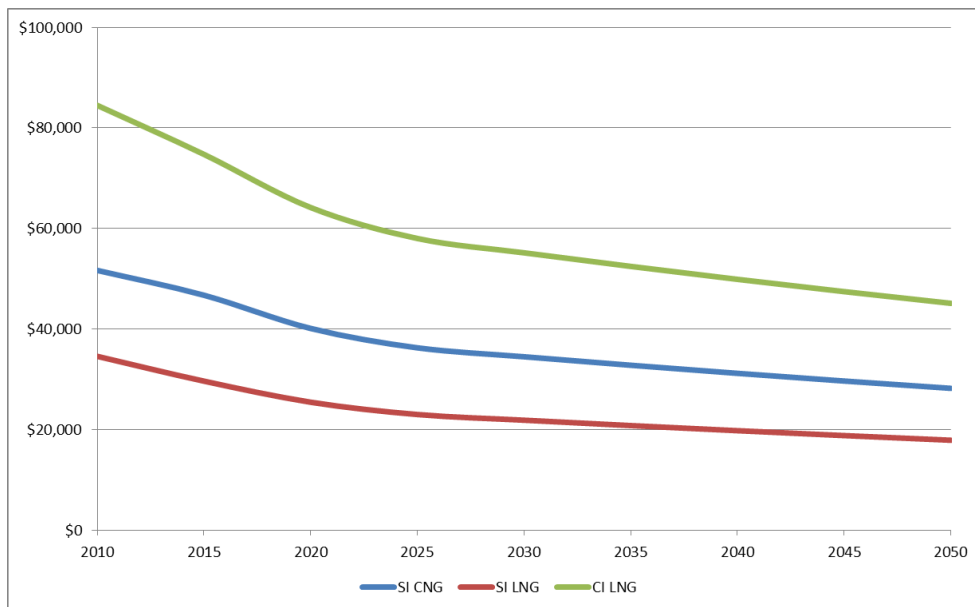

Figure 22: Estimates of incremental cost for class 7 & 8 combination tractor trailer trucks

Source: NPC, 2013. 2010 and 2015 data points are from manufacturer information and estimates. For 2020-2050, cost reductions were exogenously estimated in NPC study based on "achieving scale": 3%/yr reduction in 2015-2020, 2%/yr reduction in 2020-2025, and 1%/yr reduction in 2025-2050.

For the infrastructure cost component, a range of 200% - 400% over the cost of diesel infrastructure was tested. One data point for the cost of LNG liquefaction and distribution was from the National Petroleum Council study, which cited the Clean Energy Fuels liquefaction plant at Boron, CA built in 2007 to serve LNG vehicles at the Port of Los Angeles and Port of Long Beach. This plant cost \$70M in capital expenditure and is assumed to produce 29M DGE/year at an assumed 80% capacity utilization (approximately supplying the operation of 8 LNG fuelling stations. The capital recovery factor was based on a 10% cost of capital and 20 year lifetime amortization. The fuelling station was estimated to cost \$2.1M and dispense 3.4M DGE/yr (approximately serving the fuel needs of 150 Class 8b trucks). After dividing by the expected quantities to be dispensed, the capital expenditure for every unit of fuel was estimated to be \$0.35/DGE (NPC, 2013). This is then compared to an estimated \$0.17/DGE required for the equivalent diesel infrastructure, resulting in the 200% mark-up estimate. The distribution of LNG by truck was modelled as an operating expense.

Upon further investigation into the cost of LNG, it was found that the capital cost of large liquefaction trains at LNG export terminals had significantly different costs than those estimated for the relatively small-scale liquefaction plant at Boron. Figure 23 shows how capital expenditures for liquefaction plants have been rising to above \$1000/tonne, rather than falling as assumed for other backstop technologies. Factors that have affected the rising capital cost of LNG plants include skills and labour shortages and the rising cost of steel and cement and rising cost of greenfield development in remote locations. For comparison purposes, the NPC estimate for the Boron plant translates to an equivalent \$827/tonne.

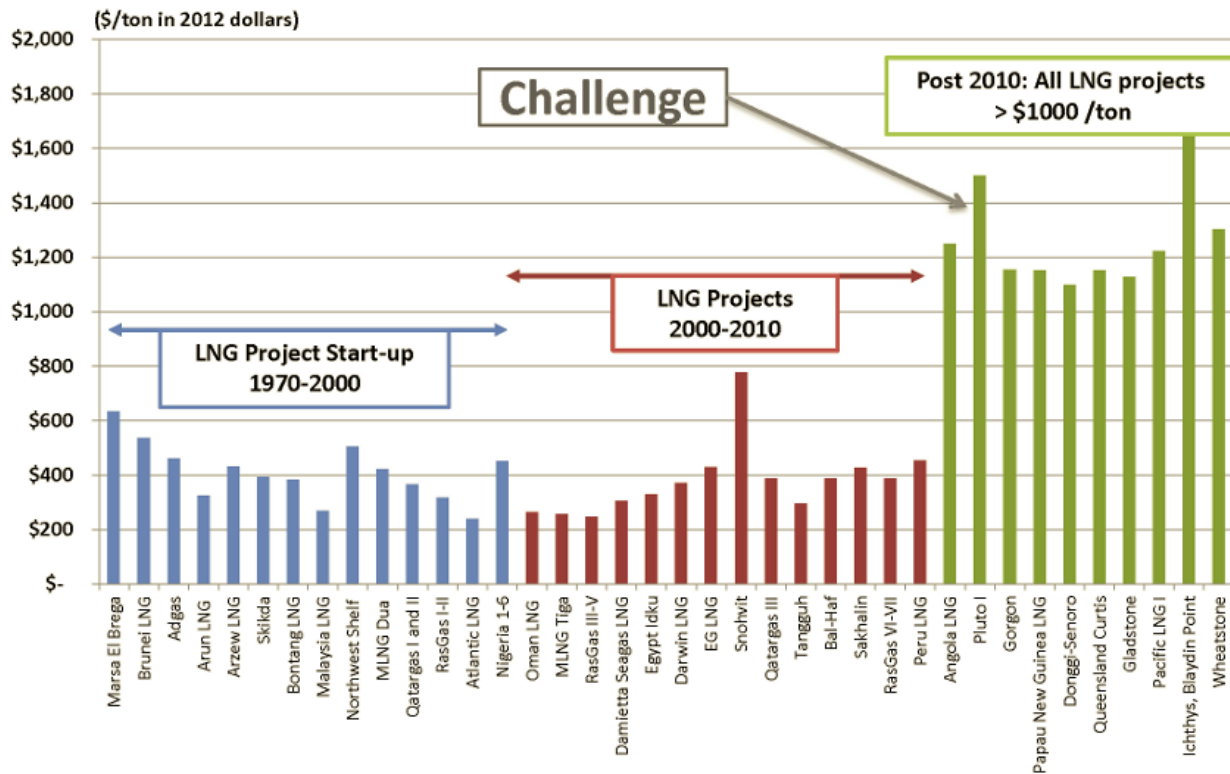

Figure 23: Capital expenditures for historical LNG liquefaction facilities

Source: Apache Corp, 2013

On the other hand, two projects that were not included in Figure 23 are Sabine Pass (\$556/tonne) and Nigeria Train 7 (\$936/tonne), but these were brownfield expansion projects at existing sites. Other points of comparison include a small-scale LNG facility based on pressure reduction turboexpansion at Sacramento, California, at an equivalent \$936/tonne, and an estimate of \$723/tonne for a LNG plant associated with nitrogen rejection and natural gas processing (TIAx, 2010).

As a comparison, the production capacity of the Boron plant is equivalent to 0.10 MMTPA (million tonnes LNG / year), while liquefaction trains at export terminals such as Sabine Pass in Louisiana have capacities in the range of 4.5 MMTPA per train (9-18 MMTPA in total at Sabine Pass by 2016-2017). This may undercut part of the argument that the n-th unit cost will benefit from large-scale production, though there may still be some learning and cost reductions to be had with future small-scale liquefaction plants.

From this analysis, and because LNG fuel cost estimates assume scale production and high plant and equipment utilization, a upper bound mark-up of 400% was selected, equivalent to twice the cost of the purpose-built LNG liquefaction plant at Boron and equivalent to \$1600/tonne.

3.9 Adoption Results under Variation in Mark-up Factor

To assess the full cost of introducing a new technology, the EPPA model was run with combinations of the range of mark-up factors centered around the base case mark-up estimates, as discussed (120%-160% for vehicle, 200%-400% for infrastructure). The results are shown in Figure 24. 10% penetration of Class 8b trucks was achieved the quickest in the United States, by 2020 at lower mark-ups and 2030 at higher mark-ups. In the United States, a wide range of mark-up combinations saw 10% penetration by 2020, including truck mark-up at 160% and LNG mark-up at 200%, which approximates the long-run cost premiums for a truck to be at today's price of the high-end compression ignition engine LNG truck and for LNG infrastructure to cost the same as it did for the Boron plant, assuming scale production and utilization of infrastructure and fuelling stations. The LNG price at this assumption of capital cost would be \$2.05/DGE (refer back to Figure 11). At the other end, truck mark-up of 110% and LNG mark-up of 320% also resulted in 10% adoption. These assumptions would approximate today's prices of spark ignition CNG and LNG heavy duty trucks in smaller segments (half the fuel tanks needed) and LNG at approximately \$2.70/DGE, which is in the range of LNG prices seen today, when it is only offered at 92 stations in the US today. The sets of assumptions in these two scenarios book-end the prices of technology and fuel seen today, approximating the long-run costs without further cost reduction expected from economies of scale and learning-by-doing. This shows that 10% penetration of LNG trucks in the Class 8b trucking segment in the United States is economically realistic.

Penetration is delayed with higher mark-ups and particularly sensitive to the uncertain infrastructure cost associated with LNG fuel. For example, in the US, with a vehicle mark-up at 130%, infrastructure mark-up going from 280% to 320% (equivalent to the representative liquefaction plant capital cost going from \$95M to

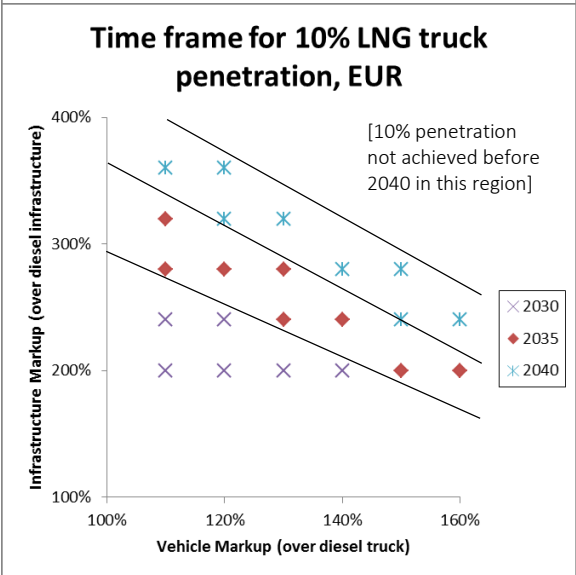
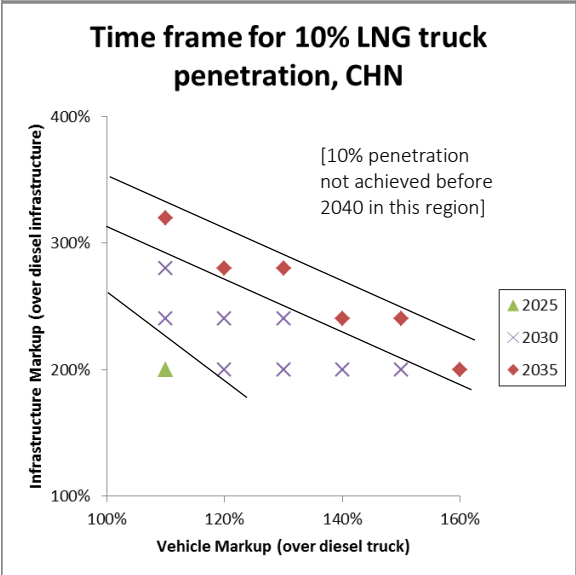
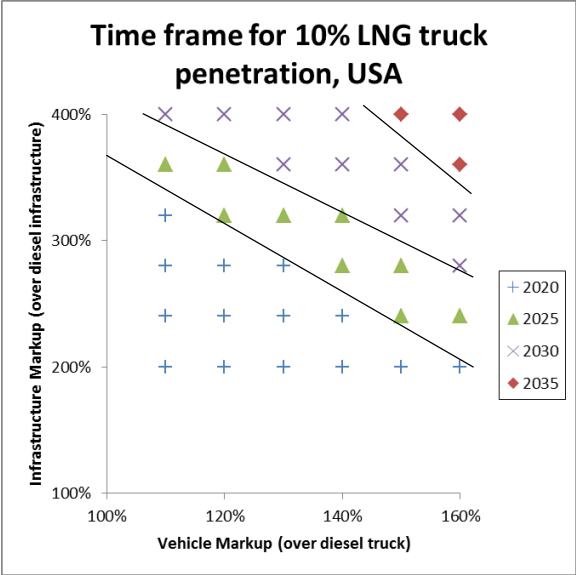

\$109M) delays the 10% penetration milestone by 5 years. At 360%, or \$122M, the 10% mark is delayed by another 5 years (2030). The eventual mark-up will depend on the utilization and scale of LNG infrastructure network in the long term.

In China and the EU where natural gas prices are modelled to be much higher than in the US, penetration milestones are delayed due to the lower economic attractiveness of the LNG backstop in these regions. It appears that decision makers in China and the EU are more sensitive to both mark-up factors than in the US, based on the thinner bands representing jumps in mark-up. In comparing adoption in China with the EU, it appears that LNG trucks are adopted earlier at lower mark-ups, but do not achieve 10% penetration at the higher mark-up combinations. At these increased mark-ups, penetration is slowed significantly so that 10% is not reached in 2040, whereas 2040 is the entry year for a band of mark-up combinations in the EU. This can be interpreted as a higher sensitivity to the non-energy costs of a LNG trucking system in China, where it is likely that the oil-gas spread is expected to be relatively weaker.

Figure 24: Time frames for 10% LNG truck penetration milestone in selected regions

To reflect the headstart in LNG infrastructure in China and the currently observed trend of using lower-cost SI LNG trucks, mark-up assumptions on the lower end for China should be considered. This puts the 10% penetration milestone in the range of 2025-2030. Given the strong policy push of the Chinese government, actualized in the form of state-owned enterprises building LNG infrastructure before the LNG trucks are purchased, it is likely that Chinese LNG truck adoption will reach 10% before the projected 2025-2030 time frame given in the results of this modelling.

3.10 Business-As-Usual Scenario Effects and Impacts

A “business-as-usual” scenario is the base economic scenario in the simulation in this section, reflecting economic behaviour only with no concern for emissions and externalities. The base case of 130% vehicle mark-up and 280% infrastructure mark-up result in the following adoption paths of LNG trucks and their impact on natural gas and transportation fuel consumption shown in Figure 25.

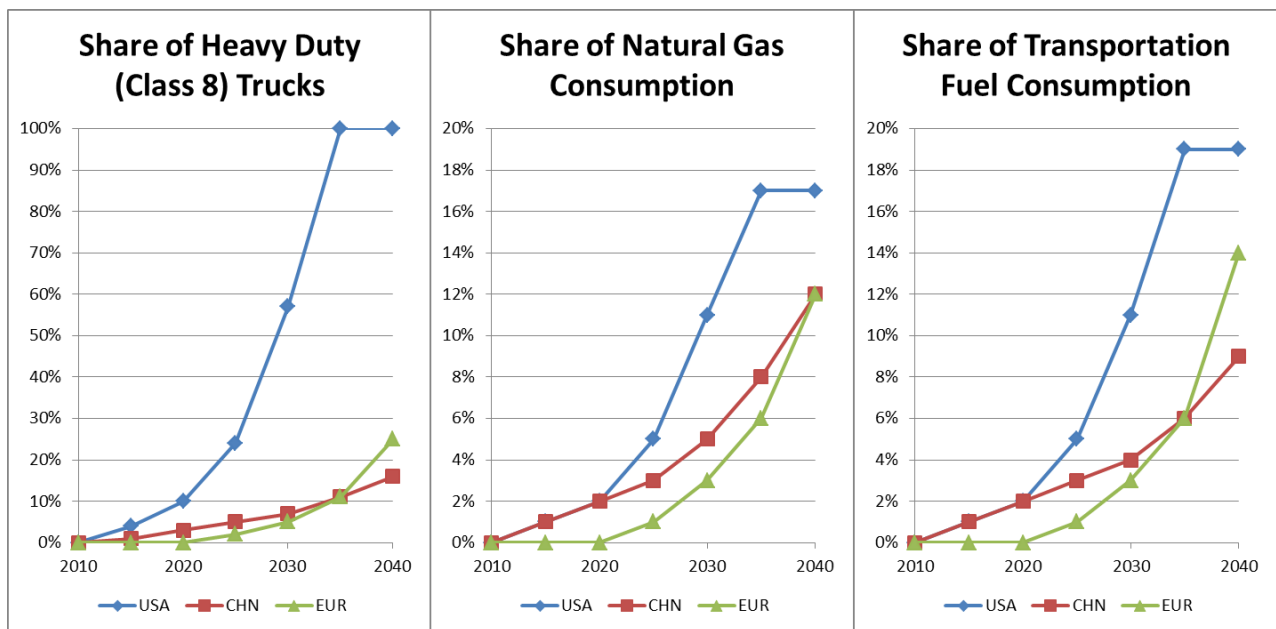

Figure 25: LNG truck adoption as share of Class 8 segment, as share of natural gas consumption in the region, and as share of transportation fuel consumption in the region

Box 4: Assumptions for Figure 25 LNG Truck Adoption Rates and Impacts

130% for truck, corresponding to \$36,000 premium over \$120,000 truck
 280% for infrastructure and operating costs, corresponding to \$980/tonne capital expenditure for liquefaction, operating costs assuming 80% utilization of capacity, and 400 mile round trip for LNG deliveries

In this scenario, 10% penetration of the Class 8 heavy duty segment is achieved by 2020 in the United States, and by 2040, all Class 8 heavy duty trucks in the United States are projected to be fuelled by LNG. These trucks would consume about 6.9 EJ (exajoules) by 2040, which would constitute 17% of total natural gas use in the US at that time and displace 19% of total transportation fuel use in the US.

The results for China and Europe show lower penetration of LNG trucks, at 18% and 25% of the Class 8 heavy duty segment by 2040. This result reflects the higher cost of natural gas in these regions. However, in China, strong government support will likely undermine these results and will encourage adoption at faster rates than this economic projection.

Another factor in these results is the regional pricing of natural gas reflecting a continuation of segmentation of natural gas markets as they exist today. The movement towards global natural gas markets with increased LNG trade and pipeline capacity would likely reduce natural gas prices in Europe and China and boost adoption rates.

As shown in Figure 26, in the United States, the effect of LNG truck penetration on natural gas prices is expected to be modest, increasing by 3%, relative to the scenario where LNG trucks are not available, in 2040 at full Class 8b truck penetration. The price of refined oil would fall by about 3% by 2040 due to reduced demand. Total GHG emissions of the United States would fall by 1.5%, relative to the scenario without LNG truck technology availability. These results reflect the relative size of this transportation segment and its energy use and emissions and the limited reductions in GHG available from switching from petroleum fuel to natural gas fuel.

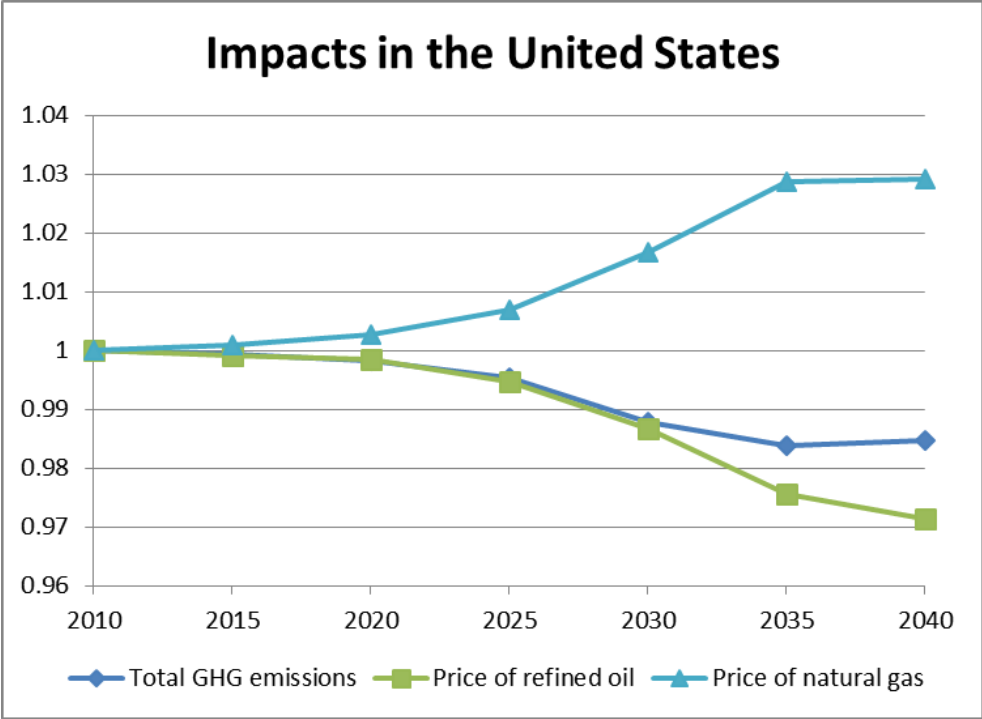

Figure 26: Impacts of LNG truck adoption on GHG and prices in the US, relative to reference scenario and prices without LNG trucks

3.11 Policy Scenario Effects on Adoption

In the EPPA model, policy scenario specifications are used to simulate expectations of climate action in the form of price-based climate change mitigation policies that constrain GHG emissions at least cost to the economy. Figures 27 and 28 show the variation in expected LNG truck adoption and natural gas use based on an illustrative sample of different climate policy scenarios, such as the Copenhagen pledges from each country as implemented in the MIT Joint Program on Global Change 2013 Energy and Climate Outlook (MIT JPSPGC, 2013), and global GHG constraints that would limit GHG emissions to 40% of 2005 levels by 2050 (“strong policy”) or achievement of a similar reduction later by 2080 (“weak policy”). The targets are specified for later dates but the periods considered here are up to 2040.

The results of these hypothetical policy scenarios are illustrative and are a sample of the EPPA model’s capabilities. In this thesis, the focus was on developing the methodology and assumptions needed for the modelling of the alternative fuel vehicle technology option of LNG trucking. As shown in Figure 27, the adoption rate

of LNG trucks could increase in the US (31% in 2025 instead of 24% and 80% in 2030 instead of 57%) and the EU as a result of stronger climate policies. This could be attributed to the larger amounts of associated GHG in petroleum-based fuel than in natural gas and therefore a higher cost savings from fuel switching. Chinese adoption rises then falls with increasing GHG constraints, likely due to competition for natural gas in other sectors.

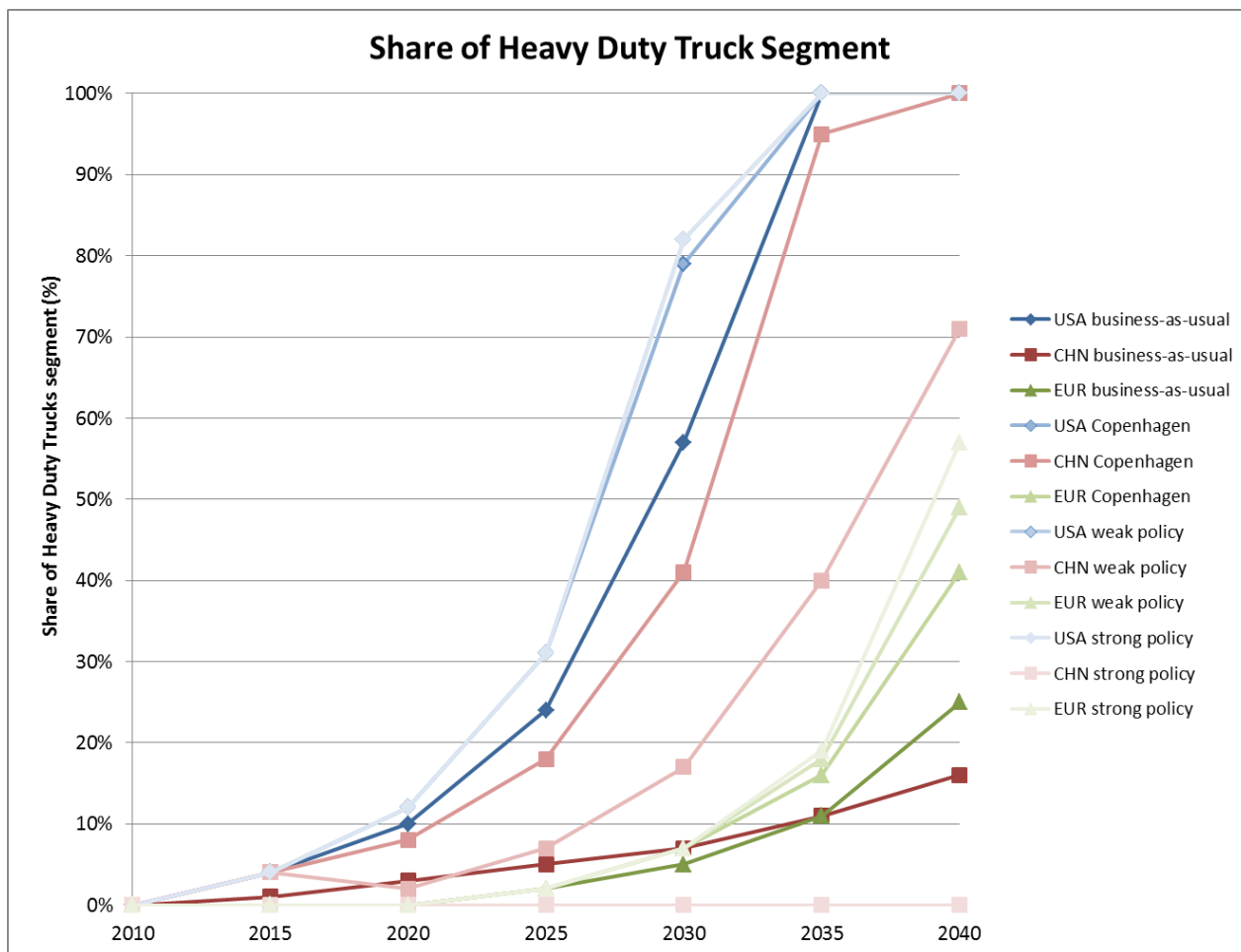

Figure 27: LNG truck adoption under climate policy scenarios

In Figure 28, the corresponding natural gas consumptions of these scenarios are shown. Because of reduced aggregate demand for transportation services in the United States in these climate change mitigation scenarios, it can be seen that natural gas consumption by LNG trucks is higher in 2030 (4.5 EJ compared to 2.7 EJ), but ends up under the BAU scenario in 2040 at 5.8 EJ compared to 6.9 EJ. Due

to the relative size of the Chinese economy, the 100% adoption in the Copenhagen scenario for China results in high consumption levels of natural gas (11.5 EJ) by LNG trucks. More detailed analysis of the impacts requires further investigation.

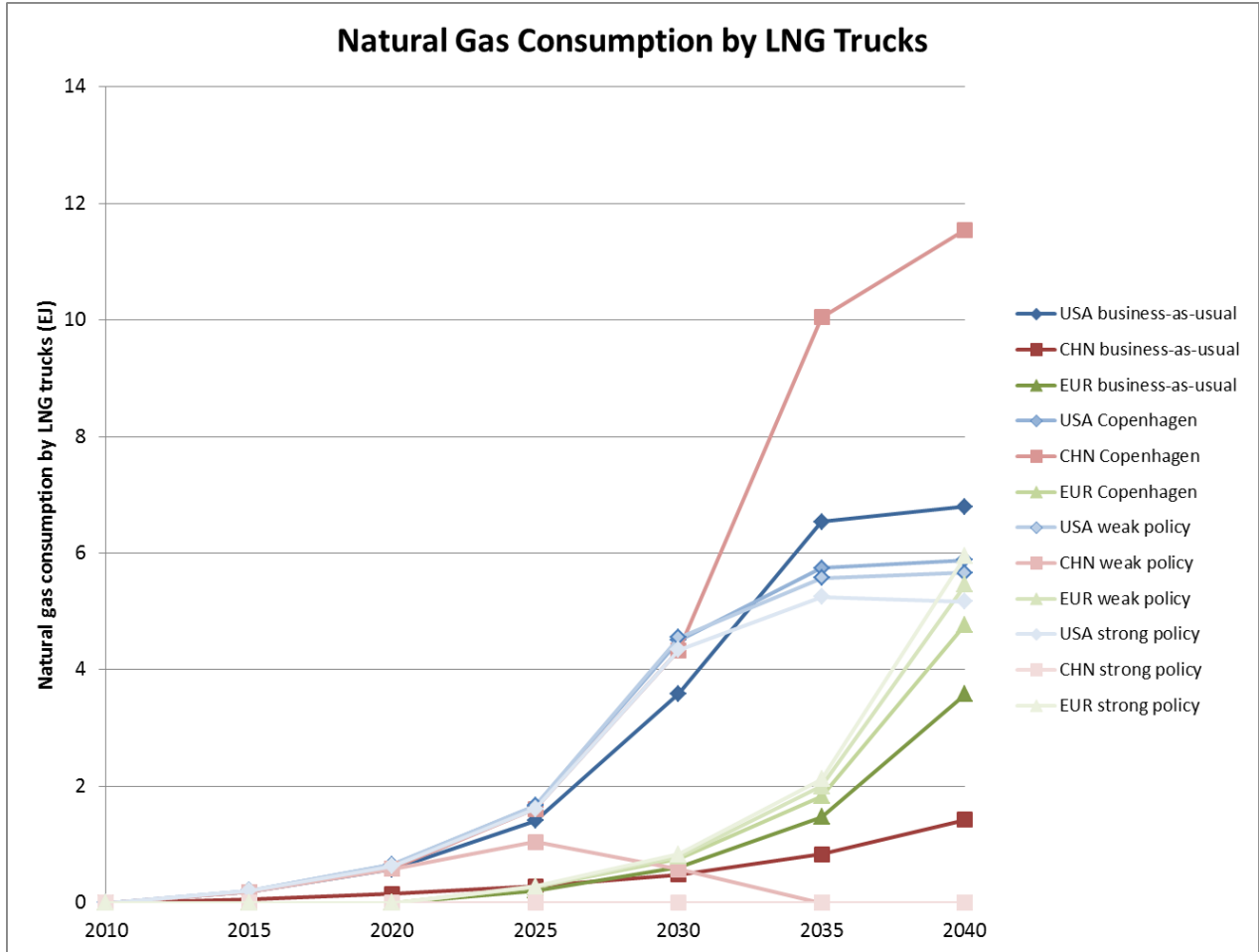

Figure 28: Natural gas consumption by LNG trucks under climate policy scenarios

4 Conclusions

Recent revised estimates of natural gas supply and development of global markets for natural gas has generated renewed interest in natural gas vehicles, especially in the freight transportation sector. Many see the opportunity to displace petroleum, the dominant transportation fuel. Light duty and heavy duty natural gas vehicles were reviewed, as well as the CNG and LNG fuel infrastructure requirements and fuel costs. Light duty CNG vehicles were excluded from further analysis due to challenges with infrastructure and cost and the scope of this study.

On a cost basis, LNG can be competitive as a diesel fuel substitute, even at low oil-gas spreads seen in EU and China. Cost decomposition and analysis showed importance of factors other than price of natural gas. On the infrastructure front, Chinese state-owned enterprises and private companies have taken the lead on building a LNG distribution network and appear poised to attract significant penetration of LNG trucks. The US effort has been led by private companies like T. Boone Pickens' Clean Energy Fuels Corp.

To understand the prospects and impacts of heavy duty LNG vehicle adoption, a CGE model was deployed to help investigate the complex effects of large-scale changes in the energy-economic system. Because cost estimates for both the vehicle and LNG infrastructure vary significantly and suffer from uncertainty and endogeneity, a range of mark-up factor settings needs to be tested while keeping the cost structure and accounting of physical energy quantities consistent. The backstop technology methodology was modified and tested for this purpose. The specification and calibration of technology-specific factor was also investigated and found to be critical to the results. Results were particularly sensitive to the mark-up factors and assumed infrastructure at scale utilization. One important modelling area of concern was the endogeneity problem in which the n -th unit cost was reached too early because the n -th cost specification arose from an exogenous assumption of a technology benefiting from scale production.

In the business-as-usual scenario, 10% penetration of the Class 8 heavy duty segment is achieved by 2020 in the United States, and by 2040, all Class 8 heavy

duty trucks in the United States are projected to be fuelled by LNG by 2040. These trucks will consume about 6.9 EJ by 2040, which would constitute 17% of total natural gas use in the US at that time and displace 19% of total transportation fuel use in the US. The results for China and Europe show lower penetration of LNG trucks, at 18% and 25% of the Class 8 heavy duty segment by 2040. This result reflects the higher cost of natural gas in these regions. However, in China, strong government support will likely undermine these results and will encourage adoption at faster rates than this economic projection. Other factors such as further development of natural gas resources in China or increased levels of global natural gas trade could reduce the cost of natural gas in China and increase LNG truck adoption in China.

In this scenario, for the United States, the effects on natural gas prices (+3%), oil prices (-3%), and total GHG emissions (-1.5%) are modest, relative to the scenario where LNG trucks are not available. Although the introduction of LNG trucks increases demand for natural gas in the United States, the impacts on overall natural gas prices is limited. At the same time, it will bring benefits of reduced payments for imported oil and reduced GHG emissions.

This thesis focuses on the methodology of representing an alternative fuel vehicle technology option, LNG trucks, in a general economic equilibrium model. A new production function and backstop technology was created and parameterized for the new LNG option. A range of assumptions for vehicle and infrastructure costs, natural gas market structures, speed of adoption of new technologies, and policy scenarios were tested. Further research is needed to explore additional assumptions and scenarios.

5 References

American Transportation Research Institute (ATRI). 200.) An Analysis of the Operational Costs of Trucking. From TRB 2010 Annual Meeting Proceedings.

America's Natural Gas Alliance (ANGA). 2009. Commissioned Report on CNG Infrastructure, performed by TIAX LLC.

Apache Corp. 2012. LNG Construction Report. Presentation.

Beveridge, N. 2013. LNG-fueled heavy-duty trucks. Report from Sanford C. Bernstein & Co. Investment Analysis.

Bloomberg News. 2014. Russia, China Sign \$400 Billion Gas Deal After Decade of Talks. May 21 2014. <http://www.bloomberg.com/news/2014-05-21/russia-signs-china-gas-deal-after-decade-of-talks.html>

China Energy News (中国能源报). 2014. "LNG 加气站发展回顾及展望" (History and Prospects of LNG filling stations). 10 Feb 2014.
http://paper.people.com.cn/zgnyb/html/2014-02/10/content_1389204.htm

CNPC (China National Petroleum Corporation). 2013. Substituting Natural Gas for Oil for Low-carbon Development.
http://ckcec.cnpc.com.cn/en/press/Features/yqdy2013_en.shtml?COLLCC=2741233219&

DOE (US Department of Energy). 2012. Clean Cities Alternative Fuel Price Report.
http://www1.eere.energy.gov/cleancities/toolbox/price_report.html

DOE (US Department of Energy). 2014. Alternative Fuels Data Center.
<http://www.afdc.energy.gov/>

EIA (US Energy Information Administration). 2013. Annual Energy Outlook 2013. Washington, DC. US Department of Energy.

EIA (US Energy Information Administration). 2013. US EIA Shale Gas Report. US EIA. US Department of Energy.

Frost and Sullivan. 2012. Strategic Analysis of the North American Class 6-8 Natural Gas Truck Market. N8CF-18. Feb 2012.

Gillespie, C. 2011. A General Equilibrium Analysis of Climate Policy for Aviation. Master's Thesis, Technology and Policy Program and MIT Joint Program on Global Change, MIT.

Gillingham, K., Newell, R.G., Pizer, W.A. 2008. Modeling endogenous technological change for climate policy analysis. *Energy Economics* 30: 2734–2753.
doi:10.1016/j.eneco.2008.03.001

Gitiaux, X., Paltsev, S., Reilly, J., Rausch, S. 2012. Biofuels, Climate Policy, and the European Vehicle Fleet. *Journal of Transport Economics and Policy*, 46(1): 1-23.

Goddard, C. 1982. Debunking the learning curve. *IEEE Transactions on Components, Hybrids, and Manufacturing Technology* 5: 328–335.
doi: 10.1109/tchmt.1982.1136009

ICCT (International Council on Clean Transportation). 2014. Global passenger vehicle standards. <http://theicct.org/info-tools/global-passenger-vehicle-standards>

IEA (International Energy Agency). 2012. World Energy Outlook 2012. OECD (Organization for Economic Co-operation and Development).

IGU (International Gas Union). 2012. Natural Gas for Vehicles. IGU Working Committee 5. Kuala Lumpur 2012 World Gas Conference.

Jacoby, H.D., Reilly, J.M., McFarland, J.R., Paltsev, S. 2006. Technology and technical change in the MIT EPPA model. *Energy Economics*, Volume 28, Issues 5–6, November 2006, Pages 610-631, ISSN 0140-9883.
<http://dx.doi.org/10.1016/j.eneco.2006.05.014>.
<http://www.sciencedirect.com/science/article/pii/S0140988306000624>

Karplus, V., Paltsev, S., Reilly, J. 2010. Prospects for plug-in hybrid electric vehicles in the United States and Japan: A general equilibrium analysis. *Transportation Research Part A: Policy and Practice*, Vol. 44(8), 620-641.

Karplus, V.J. 2011. *Climate and Energy Policy for U.S. Passenger Vehicles: A Technology-rich Economic Modeling and Policy Analysis*. Ph.D. Dissertation. Cambridge, MA: Massachusetts Institute of Technology.

Karplus, V.J., Paltsev, S., Babiker, M., Reilly, J.M., 2013. "Applying engineering and fleet detail to represent passenger vehicle transport in a computable general equilibrium model," *Economic Modelling*, vol. 30, no. January, pp. 295-305.

Kishimoto, P. 2012. *Passenger transport in China under climate constraints : general equilibrium analysis, uncertainty, and policy*. Master's Thesis. Cambridge, MA: Massachusetts Institute of Technology.

Kishimoto, P., Zhang, D., Zhang, X., Karplus, V. 2014. *Modeling Regional Transportation Demand in China and the Impacts of a National Carbon Policy*. Transportation Research Board 93rd Annual Meeting. TRB 14-2101.

Kragha, O. 2010. *Economic Implications of Natural Gas Vehicle Technology in U.S. Private Automobile Transportation*. Master's Thesis. Cambridge, MA: Massachusetts Institute of Technology.

Krupnick, A. 2010. *Energy, Greenhouse Gas, and Economic Implications of Natural Gas Trucks*. Resources for the Future. June 2010.

Lux Research. 2013. *Shale Takes on Automotive: The Future of Natural Gas Vehicles*. Client Report.

Macquarie Capital. 2012. *Natural Gas Vehicle Industry*. Macquarie Equities Research. 2 Apr 2012.

Markusen, J., Rutherford, T., 2004. *MPSGE User Guide*. Department of Economics, University of Colorado Boulder.

MITEI (MIT Energy Initiative). 2011. The Future of Natural Gas: An Interdisciplinary MIT Study. MIT Energy Initiative, Cambridge, MA.

<http://mitei.mit.edu/publications/reports-studies/future-natural-gas>

MITEI (MIT Energy Initiative). 2012. Prospects for Bi-Fuel and Flex-Fuel Light Duty Vehicles. MIT Energy Initiative, Cambridge, MA.

http://mitei.mit.edu/system/files/Alt_Fuel_Vehicles.pdf

MIT JPSPGC (MIT Joint Program on the Science and Policy of Global Change). 2013. Energy and Climate Outlook 2013

<http://globalchange.mit.edu/research/publications/other/special/2013Outlook>

Moore, G.E. 1965. Cramming more components onto integrated circuits. Electronics Magazine 38.

Morris, J.H. 2014. MIT EPPA Uncertainty Analysis. Forthcoming.

Murphy, P. 2009. The role of natural gas as a vehicle transportation fuel. Master's Thesis. MIT.

Nagy, B., Farmer, J.D., Bui, Q.M., Trancik, J.E. 2013. Statistical Basis for Predicting Technological Progress. PLoS ONE 8(2): e52669.

doi:10.1371/journal.pone.0052669

Narayanan, B., A. Aguiar and R. McDougall. 2012. Global Trade, Assistance, and Production: The GTAP 8 Data Base: Center for Global Trade Analysis, Purdue University. http://www.gtap.agecon.purdue.edu/databases/v8/v8_doco.asp

NDRC (National Development and Reform Commission), 2013. Natural Gas Utilization Policy. Government of the People's Republic of China.

NGV Communications Group, 2014. Asian NGV Communications. May 2014 issue. 87(9). <http://www.ngvjournals.com/87-9/>

NGV Global. 2011. NGV Global Knowledge Base. Retrieved May 2013, from <http://www.iangv.org>

Nijboer, M. 2010. The Contribution of Natural Gas Vehicles to Sustainable Transport. Working Paper, International Energy Agency.

Nordhaus, W. 1973. The Allocation of Energy Reserves. *Brookings Papers* 3, 529-570.

Nordhaus, W.D. 2007. Two centuries of productivity growth in computing. *The Journal of Economic History* 67: 128–159. doi: 10.1017/s0022050707000058

Nordhaus, W.D. 2009. The perils of the learning model for modeling endogenous technological change. Technical report, National Bureau of Economic Research (NBER).

NPC (National Petroleum Council). 2013. Advancing Technology for America’s Transportation Future. The Future of Transportation Fuels Report. Washington, DC.

NRC (National Research Council). 2014. Reducing the Fuel Consumption and Greenhouse Gas Emissions of Medium- and Heavy-Duty Vehicles, Phase Two, First Report. National Academy of Sciences.

Obama, B. 2014. State of the Union Address.

Paltsev, S., L. Viguier, M. Babiker, J. Reilly, and K.H. Tay. 2004. Disaggregating Household Transport in the MIT EPPA Model. Technical Note 5. MIT Joint Program on the Science and Policy of Global Change, Cambridge, MA.
http://globalchange.mit.edu/files/document/MITJPSPGC_TechNote5.pdf

Paltsev, S., J.M. Reilly, H.D. Jacoby, R.S. Eckaus, J. McFarland, M. Sarofim, M. Asadoorian, M. Babiker. 2005. The MIT Emissions Prediction and Policy Analysis (EPPA) Model, Version 4. MIT Joint Program on the Science and Policy of Global Change Report Series, Report 125, August.
http://globalchange.mit.edu/files/document/MITJPSPGC_Rpt125.pdf

Pike Research, 2011. Natural Gas Vehicles. Report from Pike Research.

Ramberg, D, 2012. “Use of CGE and EPPA.” MIT Joint Program on Global Change.

Reuters. 2011. China's onshore gas liquefaction plants.

<http://www.reuters.com/article/2011/03/04/china-lng-onshore-idAFTOE69U00D20110304>

Rubin, J., Leiby, P. 2000. Effectiveness and Efficiency of Policies to Promote Alternative Fuel Vehicles . Presented to the Transportation Research Board, 80th Annual Conference, January 7-11, 2001.

Sandoval, R., Karplus, V., Paltsev, S., Reilly, J. 2009. Modelling prospects for hydrogen powered transportation through 2100. *Journal of Transport Economics and Policy* 43(3): 291-316.

Sinclair, G., Klepper, S., Cohen, W. 2000. What's experience got to do with it? Sources of cost reduction in a large specialty chemical producer. *Management Science* 46: 28-45. doi: 10.1287/mnsc.46.1.28.15133

Standard Chartered. 2012. China natural gas vehicles. *Equity Research*. 6 Dec 2012.

TIAX, 2010. US and Canadian CNG and LNG Infrastructure Analysis. Commissioned by American Natural Gas Association. Cupertino, CA.

TIAX, 2012. US and Canadian Natural Gas Vehicle Market Analysis. Commissioned by American Natural Gas Association. Cupertino, CA.

UPS. 2014. LNG Fact Sheet.

<http://www.pressroom.ups.com/Fact+Sheets/LNG+Fact+Sheet>

USDOT (US Department of Transportation). 2002. Effects of the Alternative Motors Fuels Act. US DOE to US Congress.

Venkatesh, A., Jaramillo, P., Griffin, M., Matthews, S. 2011. Uncertainty in Life Cycle Greenhouse Gas Emissions from United States Natural Gas End-Uses and its Effects on Policy. *Environmental Science and Technology*, vol. 45, 8182-8189.

Werpy, M., Santini, D., Burnham, A., Mintz, M. 2010. Natural Gas Vehicles: Status, Barriers, and Opportunities. Energy Systems Division, Argonne National Laboratory.

Westport, 2013. Heavy Duty Natural Gas Vehicles Market Update. Presentation. Confidential.

Wright, T.P. 1936. Factors affecting the costs of airplanes. *Journal of Aeronautical Sciences* 10: 302–328. doi: 10.2514/8.155

Whyatt, G. 2010. Issues Affecting Adoption of Natural Gas Fuel in Light- and Heavy-Duty Vehicles. PNNL-19745. Richland, Washington. Sep 2010.

Yeh, S. 2007. An Empirical Analysis on the Adoption of Alternative Fuel Vehicles: The Case of Natural Gas Vehicles. *Energy Policy*, 35, 5865-5875.